

2012



PLAQUETTES  
ET DISQUES DE FREIN

BRAKE PADS  
AND DISCS

PASTIGLIE  
E DISCHI FRENO

PASTILLAS  
Y DISCOS DE FRENO

PASTILHAS  
E DISCOS DE TRAVÃO

BREMSBELÄGE  
UND BREMSSCHEIBEN

REMBLOKKEN  
EN REMSCHIJVEN

КЛОСКИ  
И ТАРЦЕ HAMULCOWE

FREN BALATALARI  
VE DISKLERI

КОЛОДКИ  
И ДИСКИ

**OptiPACK™**



**Gamme élargie  
de témoins d'usure**

Extensive range  
of wear sensors

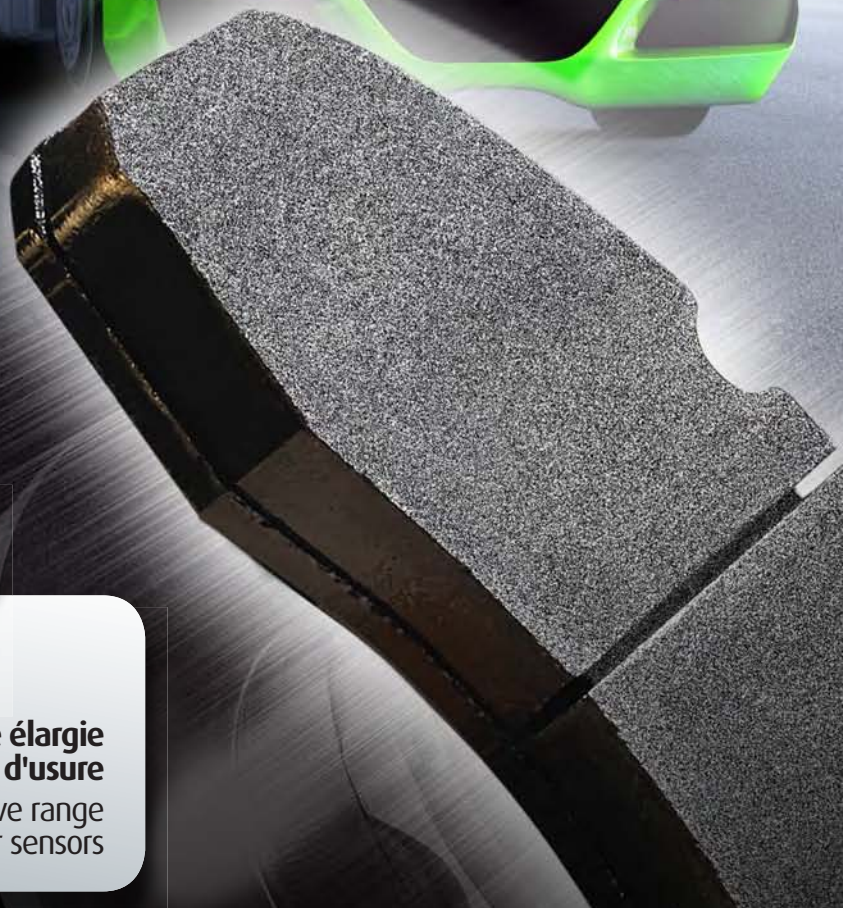

www.valeoservice.com

\*la technologie automobile, naturellement

valeo added ■■■■■

Automotive technology, naturally

**Valeo**

# OptiPACK™

**PERFORMANCE ET SÉCURITÉ OPTIMUM**  
**OPTIMUM PERFORMANCE AND SECURITY**

**Une gamme optimisée**

**57 RÉFÉRENCES**

pour une couverture de parc  
de 92% de tous les modèles PL

**An optimized range**

**57 REFERENCES**

with a 92% coverage rate  
of all European truck models

**Un pack complet**

**UNE OFFRE TOUT-EN-UN**

tous les accessoires nécessaires au  
montage sont inclus dans la boîte

**A complete package**

**ALL-IN-ONE OFFER**

all necessary accessories for  
mounting are included in the box

**Une gamme élargie  
de témoins d'usure**



**An extensive range  
of wear sensors**



valeo added™

Automotive technology, naturally

**Valeo**

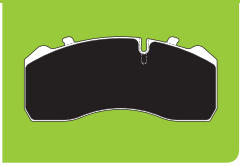

1 **OptiPACK™** >  2

2  >  5

3 **WVA** >  6

4  > **OptiPACK™** 8

5  > **OptiPACK™** 9

6 **OptiPACK™**  >   29

7  > **OptiPACK™** 59



Valeo	WVA									
882200	29087	KNORR SB7	✓		<b>MERCEDES-BENZ</b> Actros, Atego, Axor	0004210510	0004214310	247,4	109,5	30
882201	29087	KNORR SB7	✓	✓	<b>IVECO</b> Eurocargo, Eurostar, Eurotech, Stralis, Trakker	1906439	2992348	247,4	109,5	30
882202	29087	KNORR SB7	✓	✓	<b>SCANIA</b> Serie 4, P-R-T	1390428	1521979	247,4	109,5	30
882203	29087	KNORR SB7	✓	✓	<b>BPW</b> SB4345	0536270020	0980102570	247,4	109,5	30
882204	29095	KNORR SB6	✓		<b>MERCEDES-BENZ</b> Atego	0004210710		210,4	92,5	30
					<b>MAN</b> M2000	81508205017				
882205	29095	KNORR SB6	✓	✓	<b>IVECO</b> Eurocargo Tector	2992336	2996468	210,4	92,5	30
882206	29095	KNORR SB6	✓	✓	<b>BPW</b> SB3745	0980102750	0980102930	210,4	92,5	30
882207	29165	KNORR SN6	✓		<b>BPW</b> SB3745	0980106350	0980106430	210,4	92,5	30
882208	29167	KNORR SN7	✓		<b>BPW</b> SB4345	0980106960	0980106450	247,4	109,5	30
882209	29171	KNORR SK7	✓		<b>BPW</b> SB4309	0509290060	0980106440	210,2	107,8	30
882210	29115	KNORR SB5	✓		<b>MERCEDES-BENZ</b> Atego	0004211010	0004211210	185/173,5	84	34/27
882211	29030	LUCAS D3	✓		<b>IRISBUS</b> Heuliez, Agora	5001823000		249	118,1	28
					<b>RENAULT TRUCKS</b> Magnum, Premium	5001834075				
882212	29030	LUCAS D3	✓	✓	<b>IRISBUS</b> Heuliez, Agora	5001823000		249	118,1	28
					<b>RENAULT TRUCKS</b> Magnum, Premium	5001834075				
882213	29030	LUCAS D3	✓	✓	<b>IRISBUS</b> Heuliez, Agora	5001823000		249	118,1	28
					<b>RENAULT TRUCKS</b> Magnum, Premium	5001834075				
882214	29113	LUCAS D-ELSA 1	✓	✓	<b>MAN</b> F90, F2000, M2000	81508205006	81508205021	249	118,1	28
882215	29030	LUCAS D3	✓	✓	<b>MERCEDES-BENZ</b> O-Series, Integro	0024205520	0034205520	249	118,1	28
882216	29113	LUCAS D-ELSA 1	✓	✓	<b>MAN</b> NG, NU, NL Series	81508205066	81508206044	249	118,1	28
882217	29090	LUCAS D-LISA	✓	✓	<b>IRISBUS</b> Citelis, Agora, Heuliez	5001846034	5001833114	249	109,5	28
882218	29090	LUCAS D-LISA	✓	✓	<b>RENAULT TRUCKS</b> Magnum, Premium	5001846034	5001833114	249	109,5	28
882219	29131	LUCAS D-ELSA 2	✓	✓	<b>MAN</b> TGA	81508205072	81508206041	249,3	117,9	30
882220	29131	LUCAS D-ELSA 2	✓	✓	<b>RENAULT TRUCKS</b> Magnum, Premium	5001855646		249,3	117,9	30
882221	29125	LUCAS D-DUCO	✓		<b>VOLVO TRUCKS</b> FH 12/16, FM 9/12	1078439	20768092	249,1	110,9	29,3
882222	29124	MERITOR	✓		<b>MERITOR</b> DX195	MDP5076	MDP1314	205,3	102	27
882223	29088	PERROT PAN 17	✓	✓	<b>RENAULT TRUCKS</b> Midlum	5010848607		175,3	82,4	26
882224	29142	PERROT PAN 19-2	✓	✓	<b>RENAULT TRUCKS</b> Midlum	5001855902		204,5	97	29,9
882225	29090	LUCAS D-LISA	✓		<b>RENAULT TRUCKS</b> Magnum, Premium	5001846034	5001833114	249	109,5	28





Valeo	WVA										
882226	29131	LUCAS D-ELSA 2	✓		RENAULT TRUCKS	Magnum, Premium	5001855646	5001020312	249,3	117,9	30
882227	29159	PERROT PAN 19-1	✓	✓	DAF	LF 55	1628064		210,2	79,6	30
882228	29159	PERROT PAN 19-1	✓		DAF	LF 55	1628064		210,2	79,6	30
882229	29088	PERROT PAN 17	✓	✓	DAF	LF 45	1436901		175,3	82,4	26
					IVECO	Eurocargo Tector	1906467				
882230	29088	PERROT PAN 17	✓		DAF	LF 45	1436901		175,3	82,4	26
					IVECO	Eurocargo	1906467				
					RENAULT TRUCKS	Midlum	5010848607				
					MAN	L2000 , M2000	81508205023				
882231	29011	BENDIX	✓	✓	IVECO	Eurocargo, Eurostar, Eurotech	1906191	1906459	240,6	124,6	25
882232	29011	BENDIX	✓		IVECO	Eurocargo, Eurostar, Eurotech	1906191	1906459	240,6	124,6	25
882233	29122	BREMBO	✓	✓	IVECO	Eurocargo	1906416	1906298	175	79,5	22
882234	29122	BREMBO	✓	✓	IVECO	Eurocargo, Eurocargo Tector	1906416	1906298	175	79,5	22
882235	29122	BREMBO	✓		IVECO	Eurocargo, Eurocargo Tector	1906416	1906298	175	79,5	22
882236	29067	LUCAS	✓	✓	IVECO	Eurocargo	1906043	1906297	176	78	22
882237	29011	BENDIX	✓	✓	IVECO	Eurocargo, Eurostar, Eurotech	1906191	1906459	240,6	124,6	25
882238	29088	PERROT PAN 17	✓	✓	MAN	L2000 , M2000	81508206006		175,3	82,4	26
882239	29835	LUCAS	✓	✓	MERCEDES-BENZ	Vario, Medio, Sprinter	0014201520	0024205720	175	85,5	22
882240	29835	LUCAS	✓		MERCEDES-BENZ	Vario, Medio, Sprinter	0014201520	0024205720	175	85,5	22
882241	29065	LUCAS	✓	✓	RENAULT TRUCKS	Midliner S	5001014694	5001825638	175	85,5	22
882242	29065	LUCAS	✓		RENAULT TRUCKS	Midliner S	5001014694	5001825638	175	85,5	22
					IVECO	Eurocargo	1906144	1906298			
882243	29173	ELSA 225-1	✓	✓	RENAULT TRUCKS	Midlum	5001864365		216	96,5	29,25
					VOLVO TRUCKS	FL II	20568712	20568715			
882244	29173	ELSA 225-1	✓		RENAULT TRUCKS	Midlum	5001864365		216	96,5	29,25
					VOLVO TRUCKS	FL II	20568712	20568715			
882245	29174	ELSA 225-3	✓	✓	RENAULT TRUCKS	Magnum DXi, Premium DXi	5001864364	5001864363	249,6	107	29,25
					VOLVO TRUCKS	FH/FE/FM	20568711	20568714			
882246	29174	ELSA 225-3	✓		RENAULT TRUCKS	Magnum DXi, Premium DXi	5001864364	5001864363	249,6	107	29,25
					VOLVO TRUCKS	FH/FE/FM	20568711	20568714			
882247	29177	VGT195	✓	✓	RENAULT TRUCKS	Magnum DXi, Premium DXi	5001864380		210,5	99,7	29,25
					VOLVO TRUCKS	FH	20568713	20765963			
882248	29177	VGT195	✓		RENAULT TRUCKS	Magnum DXi, Premium DXi	5001864380		210,5	99,7	29,25
					VOLVO TRUCKS	FH	20568713	20765963			



<b>Valeo</b>	<b>WVA</b>									
882249	29181	HALDEX DB19	✓		<b>RENAULT TRUCKS</b> Midlum	5001866914		210	92	30
882250	29162	PERROT PAN 22-1	✓		<b>SAF-SAUER</b>	3057008400		210,5	104,3	31
882251	29143	HALDEX DB22	✓		<b>SAF-SAUER</b>	9291063		247,4	105	30
882254	29067	LUCAS	✓		<b>RENAULT TRUCKS</b> Midliner S	5001014704		176	78	22
882255	29067	LUCAS	✓	✓	<b>RENAULT TRUCKS</b> Midliner S	5001014704		176	78	22
882257	29039	LUCAS	✓	✓	<b>FORD</b> Cargo	6171272		175	78	22
					<b>VOLVO TRUCKS</b> FL 6	3090048	2709012			
882258	29067	LUCAS	✓		<b>IVECO</b> Eurocargo	1906043	1906297	176	78	22
882259	29181	HALDEX DB19	✓	✓	<b>RENAULT TRUCKS</b> Midlum	5001866914		210	92	30



			WVA				
<b>BPW</b>	0536270020	0980102570	29087	882203	882200	882303	
	0980102750	0980102930	29095	882206	882204	882306	
	980106350	0980106430	29165		882207		
	980106960	980106450	29167		882208		
	509290060	980106440	29171		882209		
<b>DAF / IVECO</b>	1436901	1906467	29088	882229	882230	882329	LF 45; Eurocargo Tector
<b>DAF / SAF-SAUER</b>	1628064		29159	882227	882228	882327	LF 55; SAF-SAUER
<b>FORD / VOLVO TRUCKS</b>	6171272	3090048	29039	882257	882254		Cargo, FL 6
<b>IRISBUS</b>	5001846034	5001833114	29090	882217	882225	882312	Citelis, Agora, Heuliez
<b>IRISBUS / RENAULT TRUCKS</b>	5001823000	5001834075	29030	882212	882211	882312	Heuliez, Renault Agora; Magnum AE, Premium
	5001823000	5001834075	29030	882213	882211	882313	Heuliez, Renault Agora; Magnum AE, Premium
<b>IVECO</b>	1906191	1906459	29011	882231	882232	882331	Eurocargo, Eurostar, Eurotech
	1906191	1906459	29011	882237	882232	882337	Eurocargo, Eurostar, Eurotech
	1906043	1906297	29067	882258	882254	882333	Eurocargo
	1906043	1906297	29067	882236	882254	882334	Eurocargo
	1906439	2992348	29087	882201	882200	882301	Eurocargo, Eurostar, Eurotech, Stralis, Trakker
	2992336	2996468	29095	882205	882204	882301	Eurocargo Tector
	1906416	1906298	29122	882233	882235	882333	Eurocargo
	1906416	1906298	29122	882234	882235	882334	Eurocargo, Eurocargo Tector
<b>MAN</b>	81508205006	81508205021	29030	882214	882211	882314	F 90, F 2000, M 2000
	81508205066	81508206044	29030	882216	882211	882316	NG/NL/NU Series
	81508206006		29088	882238	882230	882338	L2000, M2000
	81508205006	81508205021	29113	882214	882211	882314	F90, F2000, M2000
	81508205066	81508206044	29113	882216	882211	882316	NG, NU, NL Series
	81508205072	81508206041	29131	882219	882226	882319	TGA
<b>MERCEDES-BENZ</b>	0024205520	0034205520	29030	882215	882211	882315	Integro (O 550), SETRA S-Series
	0004211010	0004211210	29115		882210		Atego
	0014201520	0024205720	29835	882239	882240	882339	Vario, Medio, Sprinter
<b>MERITOR</b>	MDP5076	MDP1314	29124		882222		DX195
<b>RENAULT TRUCKS</b>	5001014694	5001825638	29065	882241	882242	882341	Midliner S
	5001014704		29067	882255	882254	882341	Midliner S
	5010848607		29088	882223	882230	882323	Midlum
	5001846034	5001833114	29090	882218	882225	882318	Magnum, Premium
	5001855646		29131	882220	882226	882320	Magnum, Premium
	5001855902		29142	882224		882324	Midlum
	5001866914		29181	882259	882249	882359	Midlum
<b>RENAULT TRUCKS / VOLVO TRUCKS</b>	5001864365		29173	882243	882244	882345	Magnum DXi, Premium DXi; FH/FE/FM
	5001864364	5001864363	29174	882245	882246	882345	Magnum DXi, Premium DXi; FH/FE/FM
	5001864380		29177	882247	882248	882345	Magnum DXi, Premium DXi; FH/FE/FM
<b>SAF-SAUER</b>	9291063		29143		882251		
	3057008400		29162		882250		
<b>SCANIA</b>	1390428	1521979	29087	882202	882200	882302	Series 4, Serie P-G-R-T
<b>VOLVO TRUCKS</b>	1078439	20768092	29125		882221		FH 12/16, FM 9/12



# WVA







WVA						
29011	882231	882232	882331	IVECO Eurocargo, Eurostar, Eurotech	1906191	1906459
	882237	882232	882337		1906191	1906459
29030	882212	882211	882312	IRISBUS Heuliez, Renault Agora; RENAULT TRUCKS Magnum AE, Premium	5001823000	5001834075
	882213	882211	882313		5001823000	5001834075
	882214	882211	882314	MAN F 90, F 2000, M 2000	81508205006	81508205021
	882215	882211	882315	MERCEDES-BENZ Integro (O 550; SETRA S-Series	0024205520	0034205520
	882216	882211	882316	MAN NG/NL/NU Series	81508205066	81508206044
29039	882257	882254		Ford Cargo, Volvo Trucks FL 6	6171272	3090048
29065	882241	882242	882341	RENAULT TRUCKS Midliner S	5001014694	5001825638
29067	882258	882254	882333	IVECO Eurocargo	1906043	1906297
	882236	882254	882334		1906043	1906297
	882255	882254	882341	RENAULT TRUCKS Midliner S	5001014704	
29087	882201	882200	882301	IVECO Eurocargo, Eurostar, Eurotech, Stralis, Trakker	1906439	2992348
	882202	882200	882302	SCANIA Series 4, Serie P-G-R-T	1390428	1521979
	882203	882200	882303	BPW; SAF-SAUER	0536270020	0980102570
29088	882223	882230	882323	RENAULT TRUCKS Midlum	5010848607	
	882229	882230	882329	DAF LF 45; IVECO Eurocargo Tector	1436901	1906467
	882238	882230	882338	MAN L2000, M2000	81508206006	
29090	882218	882225	882318	RENAULT TRUCKS Magnum, Premium	5001846034	5001833114
	882217	882225	882312	IRISBUS Citelis, Agora, Heuliez	5001846034	5001833114
29095	882206	882204	882306	BPW	0980102750	0980102930
	882205	882204	882301	IVECO Eurocargo Tector	2992336	2996468
29113	882214	882211	882314	MAN F90, F2000, M2000	81508205006	81508205021
	882216	882211	882316	MAN NG, NU, NL Series	81508205066	81508206044
29115		882210		MERCEDES-BENZ Atego	4211010	4211210
29122	882233	882235	882333	IVECO Eurocargo	1906416	1906298
	882234	882235	882334	IVECO Eurocargo, Eurocargo Tector	1906416	1906298
29124		882222		MERITOR, DX195	MDP5076	MDP1314
29125		882221		VOLVO TRUCKS FH 12/16, FM 9/12	1078439	20768092
29131	882219	882226	882319	MAN TGA	81508205072	81508206041
	882220	882226	882320	RENAULT TRUCKS Magnum, Premium	5001855646	
29142	882224		882324	RENAULT TRUCKS Midlum	5001855902	

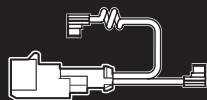

WVA						
<b>29143</b>		882251		SAF-SAUER	9291063	
<b>29159</b>	882227	882228	882327	DAF LF 55; SAF-SAUER	1628064	
<b>29162</b>		882250		SAF-SAUER	3057008400	
<b>29165</b>		882207		BPW	980106350	980106430
<b>29167</b>		882208		BPW	980106960	980106450
<b>29171</b>		882209		BPW	509290060	980106440
<b>29173</b>	882243	882244	882345	RENAULT TRUCKS Magnum DXi, Premium DXi; VOLVO TRUCKS FH/FE/FM	5001864365	
<b>29174</b>	882245	882246	882345	RENAULT TRUCKS Magnum DXi, Premium DXi; VOLVO TRUCKS FH/FE/FM	5001864364	5001864363
<b>29177</b>	882247	882248	882345	RENAULT TRUCKS Magnum DXi, Premium DXi; VOLVO TRUCKS FH/FE/FM	5001864380	
<b>29181</b>	882259	882249	882359	RENAULT TRUCKS Midlum	5001866914	
<b>29835</b>	882239	882240	882339	MERCEDES-BENZ Vario, Medio, Sprinter	0014201520	0024205720





































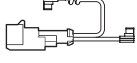
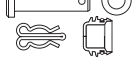







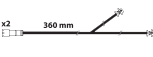







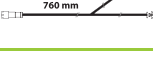

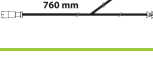

			<b>WVA</b>		
882301	882201	882200	29087	1903651	IVECO Eurocargo, Eurostar, Eurotech, Stralis, Trakker
882301	882205	882204	29095	1903651	IVECO Eurocargo Tector
882302	882202	882200	29087	1388953	SCANIA Series 4, Serie P-G-R-T
882303	882203	882200	29087		BPW; SAF-SAUER
882306	882206	882204	29095		BPW
882312	882212	882211	29030	5001834075	IRISBUS Heuliez, Renault Agora; RENAULT TRUCKS Magnum AE, Premium
882312	882217	882211	29090	5001834075	IRISBUS Heuliez, Renault Agora; RENAULT TRUCKS Magnum AE, Premium
882313	882213	882211	29030	68310622	IRISBUS Heuliez, Renault Agora; RENAULT TRUCKS Magnum AE, Premium
882314	882214	882211	29030	68323118	MAN F 90, F 2000, M 2000
882315	882215	882211	29030	3565400017	MERCEDES-BENZ Integro (O 550); SETRA S-Series
882316	882216	882211	29030	68323117	MAN NG/NL/NU Series
882318	882218	882225	29090	5001831161	RENAULT TRUCKS Magnum, Premium
882319	882219	882226	29131	68324072	MAN TGA
882320	882220	882226	29131	5001834075	RENAULT TRUCKS Magnum, Premium
882323	882223	882230	29088	5010848607	RENAULT TRUCKS Midlum
882324	882224		29142		RENAULT TRUCKS Midlum
882327	882227	882228	29159		DAF LF 55; SAF-SAUER
882329	882229	882230	29088		DAF LF 45; IVECO Eurocargo Tector
882331	882231	882232	29011	1907956	IVECO Eurocargo, Eurostar, Eurotech
882333	882233	882235	29122	1908825	IVECO Eurocargo
882333	882258	882254	29067	1908825	IVECO Eurocargo
882334	882234	882235	29122	1908407	IVECO Eurocargo, Eurocargo Tector
882334	882236	882254	29067	1908407	IVECO Eurocargo
882337	882237	882232	29011	1908231	IVECO Eurocargo, Eurostar, Eurotech
882338	882238	882230	29088	81508226014	MAN L2000, M2000
882339	882239	882240	29835	6695400917	MERCEDES-BENZ Vario, Medio, Sprinter
882341	882241	882242	29065	68320874	RENAULT TRUCKS Midliner S
882341	882255	882254	29067	68320874	RENAULT TRUCKS Midliner S
882345	882245	882246	29174	68325408	RENAULT TRUCKS Magnum DXi, Premium DXi; VOLVO TRUCKS FH/FE/FM
882345	882243	882244	29173	68325408	RENAULT TRUCKS Magnum DXi, Premium DXi; VOLVO TRUCKS FH/FE/FM
882345	882247	882248	29177	68325408	RENAULT TRUCKS Magnum DXi, Premium DXi; VOLVO TRUCKS FH/FE/FM
882352			29229		IVECO Daily 35C, 50C (2006 - ) (Front)
882353			29232		IVECO Daily 35C, 50C (2006 - ) (Rear)
882359	882259	882249	29181	5010848607	RENAULT TRUCKS Midlum
		882250	29162		SAF-SAUER
		882251	29143		SAF-SAUER

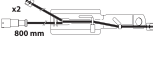

# OptiPACK™

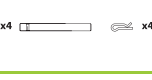
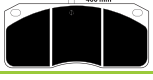
 .....

<b>BPW</b> 	<b>10</b>
<b>DAF</b> 	<b>10</b>
<b>FORD</b> 	<b>10</b>
<b>FRUEHAUF</b> 	<b>10</b>
<b>IRISBUS</b> 	<b>11</b>
<b>GENERAL TRAILERS</b> 	<b>13</b>
<b>IVECO</b> 	<b>13</b>
<b>KNORR BREMSE</b> 	<b>16</b>
<b>MAN</b> 	<b>16</b>
<b>MAN</b> 	<b>18</b>
<b>MERCEDES-BENZ</b> 	<b>19</b>
<b>MERCEDES-BENZ</b> 	<b>19</b>
<b>MERCEDES-BENZ</b> 	<b>19</b>
<b>MERITOR</b> 	<b>20</b>
<b>RENAULT TRUCKS</b> 	<b>22</b>
<b>SAF-SAUER</b> 	<b>25</b>
<b>SCANIA</b> 	<b>25</b>
<b>VOLVO TRUCKS</b> 	<b>26</b>
<b>VOLVO TRUCKS</b> 	<b>26</b>
<b>WABCO</b> 	<b>27</b>

					<b>VVA</b>	<b>Valeo</b>								
<b>BPW</b> 														
SB 3745 	KNORR SB6	1998 >		✓	29095	882204				210,4	92,5	30		
	KNORR SB6	1998 >		✓	29095	882206				210,4	92,5	30		
	KNORR SB6	1998 >		✓	29095	882306								
	KNORR SN6	2003 >		✓	29165	882207				210,4	92,5	30		
SB 4309 	KNORR SK7	2003 >		✓	29171	882209				210,2	107,8	30		
SB 4345 	KNORR SB7	1998 >		✓	29087	882200				247,4	109,5	30		
	KNORR SB7	1998 >		✓	29087	882203				247,4	109,5	30		
	KNORR SB7	1998 >		✓	29087	882303								
	KNORR SN7	2003 >		✓	29167	882208				247,4	109,5	30		
<b>DAF</b> 														
LF 45 	7.5t->12t	PERROT PAN 17	2001 >	✓	✓	29088	882229				175,3	82,4	26	
		PERROT PAN 17	2001 >	✓	✓	29088	882329							
		PERROT PAN 17	2001 >	✓	✓	29088	882230				175,3	82,4	26	
LF 55 	13t, 15t	PERROT PAN 19-1	2003 >	✓	✓	29159	882227				210,2	79,6	30	
		PERROT PAN 19-1	2003 >	✓	✓	29159	882327							
		PERROT PAN 19-1	2003 >	✓	✓	29159	882228				210,2	79,6	30	
<b>FORD</b> 														
CARGO 	LUCAS	1987>		✓	29039	882257				175	78	22		
<b>FRUEHAUF</b> 														
SB 4345 	KNORR SB7			✓	29087	882200				247,4	109,5	30		









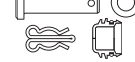
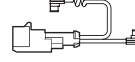



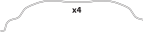

WVA

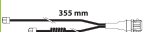
Valeo



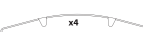







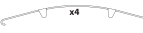

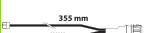
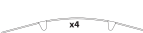













## IRISBUS

CITELIS 

LUCAS D-LISA	2005 >	✓	29090	882217				249	109,5	28
LUCAS D-LISA	2005 >	✓	29090	882312						
LUCAS D-LISA	2005 >	✓	29090	882225				249	109,5	28
LUCAS D-ELSA 2	2005 >	✓	29131	882220				249,3	117,9	30
LUCAS D-ELSA 2	2005 >	✓	29131	882320						
LUCAS D-ELSA 2	2005 >	✓	29131	882226				249,3	117,9	30













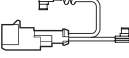





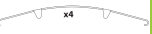



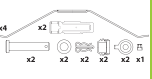





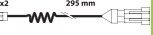

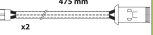

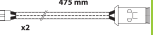
HEULIEZ 

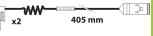

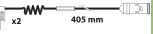
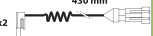

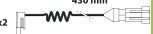
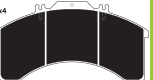
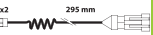









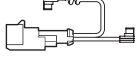
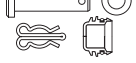





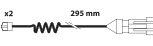

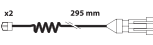



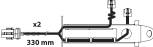

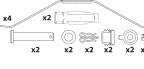











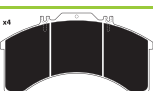

LUCAS D3	> 1998	✓	29030	882213				249	118,1	28
LUCAS D3	> 1998	✓	29030	882313						
LUCAS D3	> 1998	✓	29030	882212				249	118,1	28
LUCAS D3	> 1998	✓	29030	882312						
LUCAS D3	> 1998	✓	29030	882211				249	118,1	28
LUCAS D-LISA	1998 >	✓	29090	882218				249	109,5	28
LUCAS D-LISA	1998 >	✓	29090	882318						
LUCAS D-LISA	1998 >	✓	29090	882225				249	109,5	28
LUCAS D-LISA	2006 >	✓	29090	882217				249	109,5	28
LUCAS D-LISA	2006 >	✓	29090	882312						
LUCAS D-LISA	1998 >	✓	29090	882225				249	109,5	28
LUCAS D-ELSA 2	2006 >	✓	29131	882220				249,3	117,9	30
LUCAS D-ELSA 2	2006 >	✓	29131	882320						
LUCAS D-ELSA 2	2006 >	✓	29131	882226				249,3	117,9	30

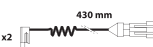
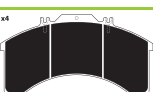
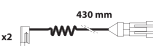

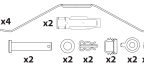

























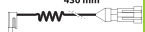

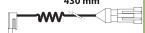



















## IRISBUS (...)

VEHICLE	MODEL	YEAR	✓	✓	WVA	Valeo	LINE	HOSE	CALIPER	PAD	W	H	T
RENAULT AGORA	LUCAS D3	1995 > 1998	✓		29030	882213					249	118,1	28
	LUCAS D3	1995 > 1998	✓		29030	882313							
	LUCAS D3	1995 > 1998	✓		29030	882212					249	118,1	28
	LUCAS D3	1995 > 1998	✓		29030	882312							
	LUCAS D3	1995 > 1998	✓		29030	882211					249	118,1	28
	LUCAS D-LISA	1998 >	✓		29090	882218					249	109,5	28
	LUCAS D-LISA	1998 >	✓		29090	882318							
	LUCAS D-LISA	1998 >	✓		29090	882217					249	109,5	28
	LUCAS D-LISA	1998 >	✓		29090	882312							
	LUCAS D-LISA	1998 >	✓		29090	882225					249	109,5	28
	LUCAS D-ELSA 2	1998 >	✓		29131	882220					249,3	117,9	30
	LUCAS D-ELSA 2	1998 >			29131	882320							
	LUCAS D-ELSA 2	1998 >	✓		29131	882226					249,3	117,9	30
RENAULT ILLIADÉ	LUCAS D3	1997 > 2000	✓	✓	29030	882213					249	118,1	28
	LUCAS D3	1997 > 2000	✓	✓	29030	882313							
	LUCAS D3	1997 > 2000	✓	✓	29030	882212					249	118,1	28
	LUCAS D3	1997 > 2000	✓	✓	29030	882312							
	LUCAS D3	1997 > 2000	✓	✓	29030	882211					249	118,1	28
	LUCAS D-ELSA 2	2000 >	✓	✓	29131	882220					249,3	117,9	30
	LUCAS D-ELSA 2	2000 >	✓	✓	29131	882320							

					WVA	Valeo						
<b>IRISBUS</b>  (...)												
RENAULT ILLIADE 	LUCAS D-ELSA 2	2000 >	✓	✓	29131	882226				249,3	117,9	30
<b>GENERAL TRAILERS</b> 												
	KNORR SB6	1998 >		✓	29095	882204				210,4	92,5	30
	KNORR SB7	1998 >		✓	29087	882200				247,4	109,5	30
<b>IVECO</b> 												
EUROCARGO 	6t, 6,7t, 7,5t, 10t	LUCAS	1991 >	✓	✓	29065	882242			175	85,5	22
	7.5t, 8t, 10t	LUCAS	1991 >	✓	✓	29067	882236			176	78	22
		LUCAS	1991 >	✓	✓	29067	882334					
		LUCAS	1991 >	✓	✓	29067	882258			176	78	22
		LUCAS	1991 >	✓	✓	29067	882333					
		LUCAS	1991 >	✓	✓	29067	882254			176	78	22
		18t	BENDIX	1991 >	✓		29011	882231			240,6	124,6
	BENDIX		1991 >	✓		29011	882331					
	BENDIX		1991 >	✓		29011	882237			240,6	124,6	25
	BENDIX		1991 >	✓		29011	882337					
	BENDIX		1991 >	✓		29011	882232			240,6	124,6	25
	6.7t, 7.5t, 10t	BREMBO	1997 >	✓	✓	29122	882234			175	79,5	22
		BREMBO	1997 >	✓	✓	29122	882334					
		BREMBO	1997 >	✓	✓	29122	882233			175	79,5	22
		BREMBO	1997 >	✓	✓	29122	882333					
		BREMBO	1997 >	✓	✓	29122	882235			175	79,5	22

														
<b>IVECO</b>  (...)														
EUROCARGO TECTOR 	6.8t->12t	BREMBO	2000 >	✓	✓	29122	<b>882234</b>				175	79,5	22	
		BREMBO	2000 >	✓	✓	29122	<b>882334</b>							
		BREMBO	2000 >	✓	✓	29122	<b>882235</b>				175	79,5	22	
	12t	PERROT PAN 17	2000 >	✓	✓	29088	<b>882229</b>				175,3	82,4	26	
		PERROT PAN 17	2000 >	✓	✓	29088	<b>882329</b>							
		PERROT PAN 17	2000 >	✓	✓	29088	<b>882230</b>				175,3	82,4	26	
	13.5t, 14t, 15t	KNORR SB6	2000 >	✓	✓	29095	<b>882204</b>				210,4	92,5	30	
		KNORR SB6	2000 >	✓	✓	29095	<b>882205</b>				210,4	92,5	30	
		KNORR SB6	2000 >	✓	✓	29095	<b>882301</b>							
15t, 18t	KNORR SB7	2000 >	✓	✓	29087	<b>882200</b>				247,4	109,5	30		
	KNORR SB7	2000 >	✓	✓	29087	<b>882201</b>				247,4	109,5	30		
	KNORR SB7	2000 >	✓	✓	29087	<b>882301</b>								
EUROSTAR 	Ch. N° < 4196457; Ch. N° < C044258	BENDIX	1993 > 2002	✓	✓	29011	<b>882231</b>				240,6	124,6	25	
		BENDIX	1993 > 2002	✓	✓	29011	<b>882331</b>							
		BENDIX	1993 > 2002	✓	✓	29011	<b>882237</b>				240,6	124,6	25	
		BENDIX	1993 > 2002	✓	✓	29011	<b>882337</b>							
		BENDIX	1993 > 2002	✓	✓	29011	<b>882232</b>				240,6	124,6	25	
	Ch. N° > 4196457; Ch. N° > C044258	KNORR SB7	1993 > 2002	✓	✓	29087	<b>882200</b>				247,4	109,5	30	
		KNORR SB7	1993 > 2002	✓	✓	29087	<b>882201</b>				247,4	109,5	30	
		KNORR SB7	1993 > 2002	✓	✓	29087	<b>882301</b>							



											
<b>IVECO</b>  (...)											
<b>EUROTECH</b>  Ch. N° < 4196457; Ch. N° < C044258	BENDIX	1992 > 1998	✓	✓	29011	882231			240,6	124,6	25
	BENDIX	1992 > 1998	✓	✓	29011	882331					
	BENDIX	1992 > 1998	✓	✓	29011	882237			240,6	124,6	25
	BENDIX	1992 > 1998	✓	✓	29011	882337					
	BENDIX	1992 > 1998	✓	✓	29011	882232			240,6	124,6	25
Ch. N° > 4196457; Ch. N° > C044258	KNORR SB7	1992 > 1998	✓	✓	29087	882200			247,4	109,5	30
	KNORR SB7	1992 > 1998	✓	✓	29087	882201			247,4	109,5	30
	KNORR SB7	1992 > 1998	✓	✓	29087	882301					
<b>EUROTECH CURSOR</b> 	KNORR SB7	1998 >	✓	✓	29087	882200			247,4	109,5	30
	KNORR SB7	1998 >	✓	✓	29087	882201			247,4	109,5	30
	KNORR SB7	1998 >	✓	✓	29087	882301					
<b>EUROTRAKKER</b> 	KNORR SB7	1993 > 2004	✓	✓	29087	882200			247,4	109,5	30
	KNORR SB7	1993 > 2004	✓	✓	29087	882201			247,4	109,5	30
	KNORR SB7	1993 > 2004			29087	882301					
<b>STRALIS</b> 	KNORR SB7	2002 >	✓	✓	29087	882200			247,4	109,5	30
	KNORR SB7	2002 >	✓	✓	29087	882201			247,4	109,5	30
	KNORR SB7	2002 >	✓	✓	29087	882301					
<b>TRAKKER</b> 	KNORR SB7	2004 >	✓		29087	882200			247,4	109,5	30
	KNORR SB7	2004 >	✓		29087	882201			247,4	109,5	30
	KNORR SB7	2004 >			29087	882301					















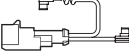





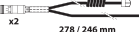
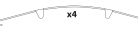

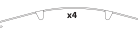

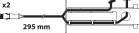



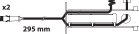

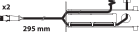

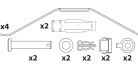





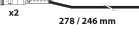

## KNORR BREMSE

	KNORR SB5			29115	882210				185/173,5	84	34/27
	KNORR SB6			29095	882204				210,4	92,5	30
	KNORR SB6			29095	882205				210,4	92,5	30
	KNORR SB6			29095	882301						
	KNORR SB6			29095	882206				210,4	92,5	30
	KNORR SB6			29095	882306						
	KNORR SB7			29087	882200				247,4	109,5	30
	KNORR SB7			29087	882201				247,4	109,5	30
	KNORR SB7			29087	882301						
	KNORR SB7			29087	882202				247,4	109,5	30
	KNORR SB7			29087	882302						
	KNORR SB7			29087	882203				247,4	109,5	30
	KNORR SB7			29087	882303						
	KNORR SN6			29165	882207				210,4	92,5	30
	KNORR SN7			29167	882208				247,4	109,5	30
	KNORR SK7			29171	882209				210,2	107,8	30

## MAN

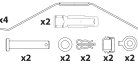











F 90	LUCAS D-ELSA 1	1990 > 1996	✓	29113	882214				249	118,1	28
	LUCAS D-ELSA 1	1990 > 1996	✓	29113	882314						
	LUCAS D-ELSA 1	1990 > 1996	✓	29113	882211				249	118,1	28

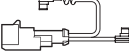





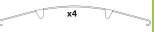





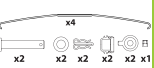

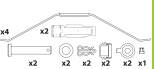
												
<b>MAN  (...)</b>												
F 2000 	LUCAS D-ELSA 1	1994 >	✓	29113	<b>882214</b>				249	118,1	28	
	LUCAS D-ELSA 1	1994 >	✓	29113	<b>882314</b>							
	LUCAS D-ELSA 1	1994 >	✓	29030	<b>882211</b>				249	118,1	28	
L 2000 	PERROT PAN 17	1996 >	✓	✓	29088	<b>882238</b>			175,3	82,4	26	
	PERROT PAN 17	1996 >	✓	✓	29088	<b>882338</b>						
	PERROT PAN 17	1996 >	✓	✓	29088	<b>882230</b>			175,3	82,4	26	
M 2000 	12t	PERROT PAN 17	1995 >	✓	✓	29088	<b>882238</b>			175,3	82,4	26
		PERROT PAN 17	1995 >	✓	✓	29088	<b>882338</b>					
		PERROT PAN 17	1995 >	✓	✓	29088	<b>882230</b>			175,3	82,4	26
	14t	KNORR SB6	1995 >	✓		29095	<b>882204</b>			210,4	92,5	30
	15t, 18t, 25t	LUCAS D-ELSA 1	1995 >	✓		29113	<b>882214</b>			249	118,1	28
		LUCAS D-ELSA 1	1995 >	✓		29113	<b>882314</b>					
		LUCAS D-ELSA 1	1995 >	✓		29113	<b>882211</b>			249	118,1	28
TGA 	LUCAS D-ELSA 1	2000 > 2001	✓	✓	29113	<b>882214</b>			249	118,1	28	
	LUCAS D-ELSA 1	2000 > 2001	✓	✓	29113	<b>882314</b>						
	LUCAS D-ELSA 1	2000 > 2001	✓	✓	29030	<b>882211</b>			249	118,1	28	
	LUCAS D-ELSA 2	2001 >	✓	✓	29131	<b>882219</b>			249,3	117,9	30	
	LUCAS D-ELSA 2	2001 >	✓	✓	29131	<b>882319</b>						
	LUCAS D-ELSA 2	2001 >	✓	✓	29131	<b>882226</b>			249,3	117,9	30	
	KNORR SB7	2003 >	✓	✓	29087	<b>882200</b>			247,4	109,5	30	













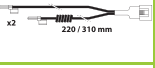
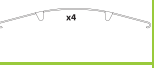

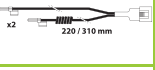
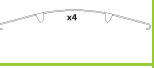







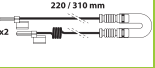

MAN  (...)												
TGL	8t->12t	KNORR SB5	2005 >	✓	✓	29115	882210			186/173,5	84	34/27
TGM	12t->15t	KNORR SB6	2006 >	✓	✓	29095	882204			210,4	92,5	30
TGM	18t->26t	KNORR SB7	2006 >	✓	✓	29087	882200			247,4	109,5	30
TGS		KNORR SB7	2007 >	✓	✓	29087	882200			247,4	109,5	30
TGX		KNORR SB7	2007 >	✓	✓	29087	882200			247,4	109,5	30

MAN												
EL/EM SERIES	LUCAS D-ELSA 1	1993 >	✓			29113	882214			249	118,1	28
	LUCAS D-ELSA 1	1993 >	✓			29113	882314					
	LUCAS D-ELSA 1	1993 >	✓			29113	882211			249	118,1	28
LION'S COACH	LUCAS D-ELSA 1	1995 >	✓	✓		29113	882214			249	118,1	28
	LUCAS D-ELSA 1	1995 >	✓	✓		29113	882314					
	LUCAS D-ELSA 1	1995 >	✓	✓		29113	882211			249	118,1	28
LION'S STAR	LUCAS D-ELSA 1	1993 >	✓	✓		29113	882214			249	118,1	28
	LUCAS D-ELSA 1	1993 >	✓	✓		29113	882314					
	LUCAS D-ELSA 1	1993 >	✓	✓		29113	882211			249	118,1	28
NL/UL SERIES	LUCAS D-ELSA 1	1992 >	✓	✓		29113	882216			249	118,1	28
	LUCAS D-ELSA 1	1992 >	✓	✓		29113	882316					
	LUCAS D-ELSA 1	1992 >	✓	✓		29113	882211			249	118,1	28
NG/NU SERIES	LUCAS D-ELSA 1	1998 >	✓	✓		29113	882216			249	118,1	28
	LUCAS D-ELSA 1	1998 >	✓	✓		29113	882316					

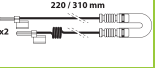
				<b>WVA</b>	<b>Valeo</b>						
<b>MAN  (...)</b>											
NG/NU SERIES 	LUCAS D-ELSA 1	1998 >	✓	✓	29113	882211			249	118,1	28

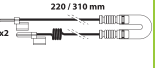
<b>MERCEDES-BENZ </b>												
ATEGO I-II 	6.5t->10.5t	KNORR SB5	1998 >	✓	✓	29115	882210			185/173,5	84	34/27
	12t->15t	KNORR SB6	1998 >	✓	✓	29095	882204			210,4	92,5	30
	18t->26t	KNORR SB7	1998 >	✓	✓	29087	882200			247,4	109,5	30
ACTROS 		KNORR SB7	1996 >	✓	✓	29087	882200			247,4	109,5	30
AXOR 		KNORR SB7	2002 >	✓	✓	29087	882200			247,4	109,5	30

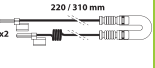
<b>MERCEDES-BENZ </b>												
INTEGRO (O 550) 	LUCAS D3	2000 >	✓		29030	882215				249	118,1	28
	LUCAS D3	2000 >	✓		29030	882315						
	LUCAS D3	2000 >	✓		29030	882211				249	118,1	28
O 340/350/404 	LUCAS D3	2000 >	✓	✓	29030	882215				249	118,1	28
	LUCAS D3	2000 >	✓	✓	29030	882315						
	LUCAS D3	2000 >	✓	✓	29030	882211				249	118,1	28

<b>MERCEDES-BENZ </b>												
MEDIO 	LUCAS	2002>	✓	✓	29835	882239				175	85,5	22
	LUCAS	2002>	✓	✓	29835	882339						
	LUCAS	2002>	✓	✓	29835	882240				175	85,5	22
SPRINTER (905) 	LUCAS	2001>		✓	29835	882239				175	85,5	22
	LUCAS	2001>		✓	29835	882339						
	LUCAS	2001>		✓	29835	882240				175	85,5	22



## MERCEDES-BENZ (…)

VARIO	LUCAS	1996 >	✓	✓	29835	882239			x4	175	85,5	22
	LUCAS	1996 >	✓	✓	29835	882339						
	LUCAS	1996 >	✓	✓	29835	882240			x4	175	85,5	22

## MERITOR

	LUCAS			✓	29065	882241			x4	175	85,5	22
	LUCAS			✓	29065	882341						
	LUCAS			✓	29065	882242			x4	175	85,5	22
	LUCAS			✓	29067	882255		x4	x4	176	78	22
	LUCAS			✓	29067	882236	x2	x4	x4	176	78	22
	LUCAS			✓	29067	882334	x2					
	LUCAS			✓	29067	882258		x4	x4	176	78	22
	LUCAS			✓	29067	882333						
	LUCAS D3			✓	29030	882213		x4	x4	249	118,1	28
	LUCAS D3			✓	29030	882313						
	LUCAS D3			✓	29030	882212		x2	x4	249	118,1	28
	LUCAS D3			✓	29030	882312		x2				
	LUCAS D3			✓	29030	882211		x4	x4	249	118,1	28
	LUCAS D-DUCO			✓	29125	882221		x4	x4	249,1	110,9	29,3
	LUCAS D-ELSA 1			✓	29113	882214		x4	x4	249	118,1	28
	LUCAS D-ELSA 1			✓	29113	882314						







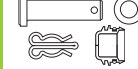
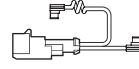











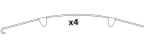

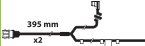
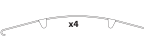

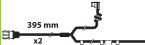

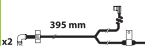

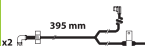









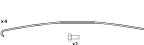

WVA

Valeo



## MERITOR (...)

	LUCAS D-ELSA 1		✓	29113	882216				249	118,1	28
	LUCAS D-ELSA 1		✓	29113	882316						
	LUCAS D-ELSA 1		✓	29113	882211				249	118,1	28
	LUCAS D-ELSA 2		✓	29131	882219				249,3	117,9	30
	LUCAS D-ELSA 2		✓	29131	882319						
	LUCAS D-ELSA 2		✓	29131	882220				249,3	117,9	30
	LUCAS D-ELSA 2		✓	29131	882320						
	LUCAS D-ELSA 2		✓	29131	882226				249,3	117,9	30
	LUCAS D-LISA		✓	29090	882218				249	109,5	28
	LUCAS D-LISA		✓	29090	882318						
	LUCAS D-LISA		✓	29090	882217				249	109,5	28
	LUCAS D-LISA		✓	29090	882312						
	LUCAS D-LISA		✓	29090	882225				249	109,5	28
	DX 195 LM		✓	29124	882222				205,3	102	27
	ELSA 225-1		✓	29173	882243				216	96,5	29,25
	ELSA 225-1		✓	29173	882345						
	ELSA 225-1		✓	29173	882244				216	96,5	29,25
	ELSA 225-3		✓	29174	882245				249,6	107	29,25
	ELSA 225-3		✓	29174	882345						
	ELSA 225-3		✓	29174	882246				249,6	107	29,25



























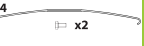













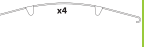

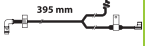

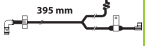



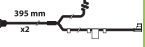
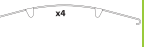

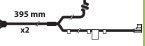



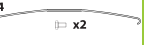































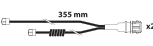

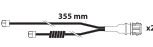

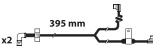

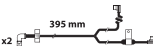



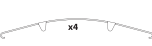

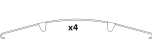







## MERITOR (…)

	VGT195		✓	29177	882247				210,5	99,7	29,25
	VGT195		✓	29177	882345						
	VGT195		✓	29177	882248				210,5	99,7	29,25

## RENAULT TRUCKS

MIDLINER S	6t->6.85t	LUCAS	1990 >	✓		29065	882241				175	85,5	22
		LUCAS	1990 >	✓		29065	882341						
		LUCAS	1990 >	✓		29065	882242				175	85,5	22
	7.5->9.5t	LUCAS	1990 >	✓		29067	882255				176	78	22
		LUCAS	1990 >	✓		29067	882341						
		LUCAS	1990 >	✓		29067	882254				176	78	22
MIDLUM	7.5->12t	PERROT PAN 17	2000 >	✓	✓	29088	882223				175,3	82,4	26
		PERROT PAN 17	2000 >	✓	✓	29088	882323						
		PERROT PAN 17	2000 >	✓	✓	29088	882230				175,3	82,4	26
	13->18t	PERROT PAN 19-2	2001 >	✓	✓	29142	882224				204,5	97	29,9
		PERROT PAN 19-2	2001 >	✓	✓	29142	882324						
	7.5t	PERROT PAN 17	2006 >	✓	✓	29088	882223				175,3	82,4	26
		PERROT PAN 17	2006 >	✓	✓	29088	882323						
		PERROT PAN 17	2006 >	✓	✓	29088	882230				175,3	82,4	26
	10t	HALDEX DB19	2006 >	✓	✓	29181	882259				210	92	30
		HALDEX DB19	2006 >	✓	✓	29181	882249				210	92	30

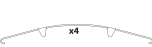
														
RENAULT TRUCKS  (...)														
MIDLUM 	10t	HALDEX DB19	2006 >	✓	✓	29181	882359							
	12t->18t	ELSA 225-1	2006 >	✓	✓	29173	882243				216	96,5	29,25	
		ELSA 225-1	2006 >	✓	✓	29173	882345							
		ELSA 225-1	2006 >	✓	✓	29173	882244				216	96,5	29,25	
MAGNUM AE 	LUCAS D3	1993 > 1996	✓		29030	882213				249	118,1	28		
	LUCAS D3	1993 > 1996	✓		29030	882313								
	LUCAS D3	1993 > 1996	✓		29030	882212				249	118,1	28		
	LUCAS D3	1993 > 1996	✓		29030	882312								
	LUCAS D3	1993 > 1996	✓		29030	882211				249	118,1	28		
	LUCAS D-LISA	1996 > 2000	✓		29090	882218				249	109,5	28		
	LUCAS D-LISA	1996 > 2000	✓		29090	882318								
	LUCAS D-LISA	1996 > 2000	✓		29090	882225				249	109,5	28		
MAGNUM E.TECH 	LUCAS D-ELSA 2	2000 >	✓	✓	29131	882220				249,3	117,9	30		
	LUCAS D-ELSA 2	2000 >	✓	✓	29131	882320								
	LUCAS D-ELSA 2	2000 >	✓	✓	29131	882226				249,3	117,9	30		
MAGNUM DXi 	ELSA 225-3	2004 >	✓	✓	29174	882245				249,6	107	29,25		
	ELSA 225-3	2004 >	✓	✓	29174	882345								
	ELSA 225-3	2004 >	✓	✓	29174	882246				249,6	107	29,25		
	lifting axle	VGT195	2004 >		✓	29177	882247				210,5	99,7	29,25	
		VGT195	2004 >	✓		29177	882345							











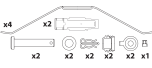





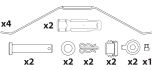

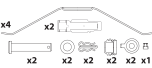

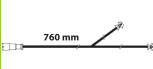

																		
<b>RENAULT TRUCKS</b>  (...)																		
MAGNUM DXi 	lifting axle	VGT195	2004 >	✓	29177	882248		x4		x2		x4	210,5	99,7	29,25			
PREMIUM 		LUCAS D3	1996 > 2000	✓	29030	882213			x4			x4	249	118,1	28			
		LUCAS D3	1996 > 2000	✓	29030	882313												
		LUCAS D3	1996 > 2000	✓	29030	882212			x2	x4		x4	249	118,1	28			
		LUCAS D3	1996 > 2000	✓	29030	882312			x2									
		LUCAS D3	1996 > 2000	✓	29030	882211				x4				x4	249	118,1	28	
		LUCAS D-LISA	1996 > 2000	✓	29090	882218			x2	x4		x4		x4	249	109,5	28	
		LUCAS D-LISA	1996 > 2000	✓	29090	882318			x2									
		LUCAS D-LISA	1996 > 2000	✓	29090	882225				x4				x4	249	109,5	28	
		LUCAS D-ELSA 2	2000 >	✓	✓	29131	882220			x2	x4		x4		x4	249,3	117,9	30
		LUCAS D-ELSA 2	2000 >	✓	✓	29131	882320			x2								
		LUCAS D-ELSA 2	2000 >	✓	✓	29131	882226				x4			x4	249,3	117,9	30	
		PREMIUM DXi 		ELSA 225-3	2005 >	✓	✓	29174	882245		x2	x4		x2		x4	249,6	107
ELSA 225-3	2005 >			✓	✓	29174	882345											
ELSA 225-3	2005 >			✓	✓	29174	882246			x4		x2		x4	249,6	107	29,25	
lifting axle	VGT195		2005 >	✓	29177	882247			x2	x4		x2		x4	210,5	99,7	29,25	
	VGT195		2005 >	✓	29177	882345												
	VGT195		2005 >	✓	29177	882248				x4		x2		x4	210,5	99,7	29,25	
R-MAJOR 		LUCAS D3	1993 > 1996	✓	29030	882213				x4		x4	249	118,1	28			
		LUCAS D3	1993 > 1996	✓	29030	882313												

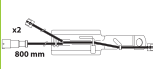

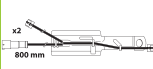





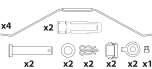

## RENAULT TRUCKS (...)

R-MAJOR 	LUCAS D3	1993 > 1996	✓		29030	882212				249	118,1	28
	LUCAS D3	1993 > 1996	✓		29030	882312						
	LUCAS D3	1993 > 1996	✓		29030	882211				249	118,1	28

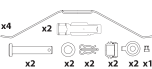
## SAF-SAUER

SK 9019, 11019 K 	KNORR SB6			✓	29095	882204				210,4	92,5	30
	KNORR SB6			✓	29095	882206				210,4	92,5	30
	KNORR SB6			✓	29095	882306						
SK 9022, 11222 K 	KNORR SB7			✓	29087	882200				247,4	109,5	30
	KNORR SB7			✓	29087	882203				247,4	109,5	30
	KNORR SB7			✓	29087	882303						
	KNORR SK7			✓	29171	882209				210,2	107,8	30
SK 9019/11019 W 	PERROT PAN 19-1			✓	29159	882227				210,2	79,6	30
	PERROT PAN 19-1			✓	29159	882327						
	PERROT PAN 19-1			✓	29159	882228				210,2	79,6	30
SK RB 9022 W 	PERROT PAN 22-1			✓	29162	882250				210,5	104,3	31
SK RB 9022 H 	HALDEX DB22			✓	29143	882251				247,4	105	30

## SCANIA

SERIES 4 	KNORR SB7	1996 >	✓	✓	29087	882200				247,4	109,5	30
	KNORR SB7	1996 >	✓	✓	29087	882202				247,4	109,5	30
	KNORR SB7	1996 >	✓	✓	29087	882302						
SERIE P-G-R-T 	KNORR SB7	2004 >	✓	✓	29087	882200				247,4	109,5	30













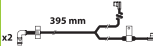

SCANIA (…)												
SERIE P-G-R-T	KNORR SB7	2004 >	✓	✓	29087	882202				247,4	109,5	30
	KNORR SB7	2004 >	✓	✓	29087	882302						
	KNORR SB7	2004 >	✓	✓	29087	882200				247,4	109,5	30

VOLVO TRUCKS													
FH 12 / FH 16	LUCAS D-DUCO	2001 >	✓	✓	29125	882221				249,1	110,9	29,3	
FH/ FE/ FM	ELSA 225-3	2005 >	✓	✓	29174	882245				249,6	107	29,25	
	ELSA 225-3	2005 >	✓	✓	29174	882345							
	ELSA 225-3	2005 >	✓	✓	29174	882246				249,6	107	29,25	
FH	lifting axle	VGT195	2005 >		✓	29177	882247				210,5	99,7	29,25
		VGT195	2005 >		✓	29177	882345						
		VGT195	2005 >		✓	29177	882248				210,5	99,7	29,25
FM 9	LUCAS D-DUCO	2001 > 2005	✓		29125	882221				249,1	110,9	29,3	
FM 12	LUCAS D-DUCO	2001 >	✓	✓	29125	882221				249,1	110,9	29,3	
FL 6	LUCAS	1990 > 1998	✓	✓	29039	882257				175	78	22	
FL-SERIES	18t	LUCAS D-DUCO	2000 >	✓	✓	29125	882221				249,1	110,9	29,3
FL II	12t->18t	ELSA 225-1	2006 >	✓	✓	29173	882243				216	96,5	29,25
		ELSA 225-1	2006 >	✓	✓	29173	882345						
		ELSA 225-1	2006 >	✓	✓	29173	882244				216	96,5	29,25

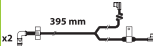











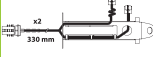
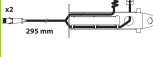

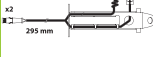
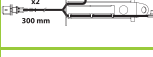
VOLVO TRUCKS												
B-10	LUCAS D-LISA	1995 >	✓		29090	882218				249	109,5	28
	LUCAS D-LISA	1995 >	✓		29090	882318						

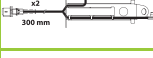

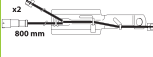
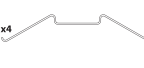
## VOLVO TRUCKS (...)

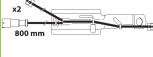
B-10 	LUCAS D-LISA	1995 >	✓	29090	882225				249	109,5	28
B-12 	LUCAS D-LISA	1992 >	✓	29090	882218				249	109,5	28
	LUCAS D-LISA	1992 >	✓	29090	882318						
	LUCAS D-LISA	1992 >	✓	29090	882225				249	109,5	28
B-12 M 	LUCAS D-DUCO	2001 >	✓	✓	29125	882221			249,1	110,9	29,3

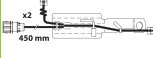
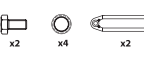
## WABCO

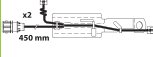
PAN 17 	PERROT PAN 17			29088	882229				175,3	82,4	26
	PERROT PAN 17			29088	882329						
	PERROT PAN 17			29088	882238				175,3	82,4	26
	PERROT PAN 17			29088	882338						
	PERROT PAN 17			29088	882223				175,3	82,4	26
	PERROT PAN 17			29088	882323						
	PERROT PAN 17			29088	882230				175,3	82,4	26
PAN 19-1 	PERROT PAN 19-1			29159	882227				210,2	79,6	30
	PERROT PAN 19-1			29159	882327						
	PERROT PAN 19-1			29159	882228				210,2	79,6	30
	PERROT PAN 19-2			29142	882224				204,5	97	29,9
	PERROT PAN 19-2			29142	882324						







# OptiPACK™

882200	30	882229	44
882201	30	882230	45
882202	31	882231	45
882203	31	882232	46
882204	32	882233	46
882205	32	882234	47
882206	33	882235	47
882207	33	882236	48
882208	34	882237	48
882209	34	882238	49
882210	35	882239	49
882211	35	882240	50
882212	36	882241	50
882213	36	882242	51
882214	37	882243	51
882215	37	882244	52
882216	38	882245	52
882217	38	882246	53
882218	39	882247	53
882219	39	882248	54
882220	40	882249	54
882221	40	882250	55
882222	41	882251	55
882223	41	882254	56
882224	42	882255	56
882225	42	882257	57
882226	43	882258	57
882227	43	882259	58
882228	44		

**882200**

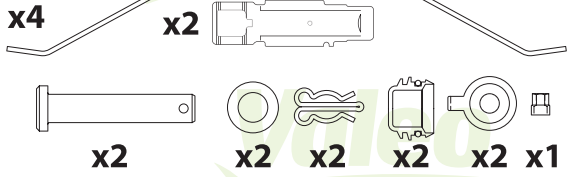
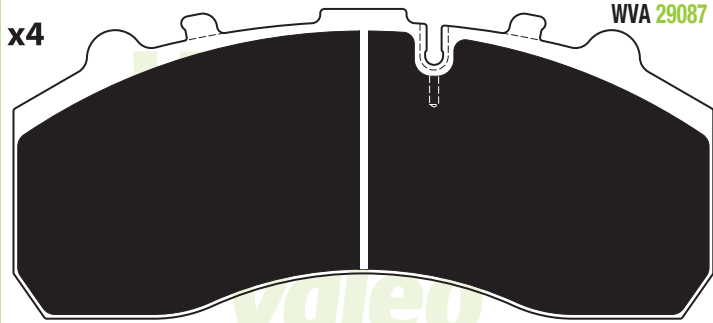

	OES
247,4 109,5 30	KNORR SB7 MERCEDES-BENZ Actros Atego Axor 0004210510 0004214310

**187051**

**187069**

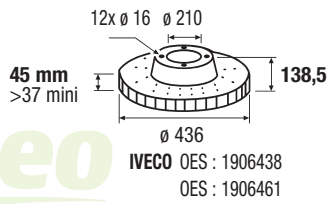
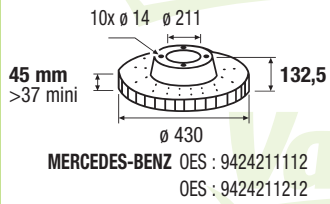

**187070**

**187136**

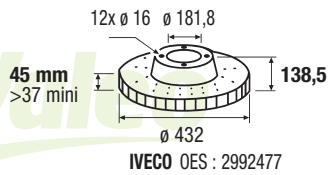
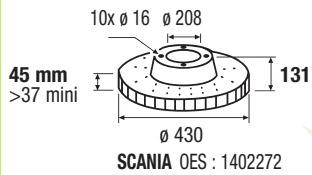

**882201**

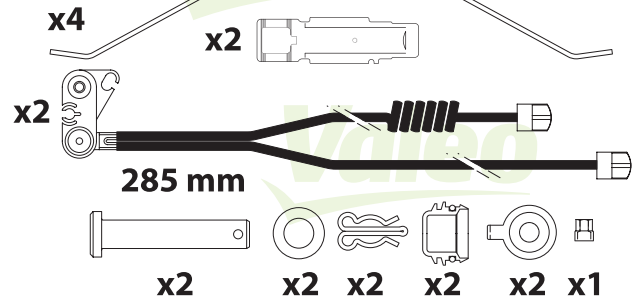
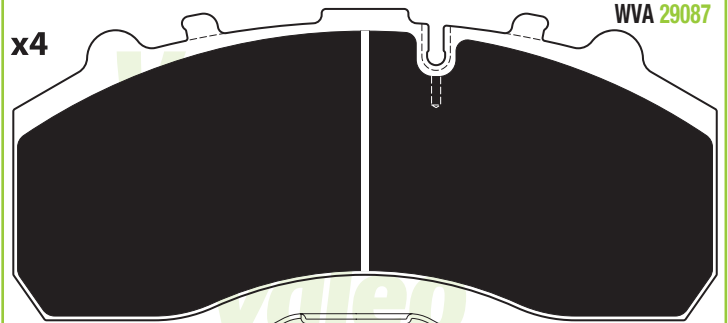

	OES
247,4 109,5 30	KNORR SB7 IVECO Eurocargo Eurostar Eurotech Stralis Trakker 1906439 2992348

**882301**



WVA		OES
29087	KNORR SB7	1903651

**187069**

**187136**

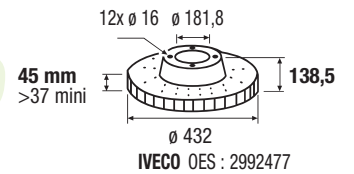
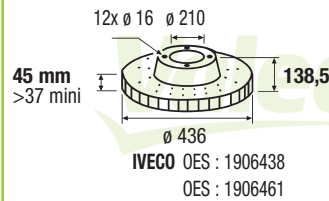



## 882204

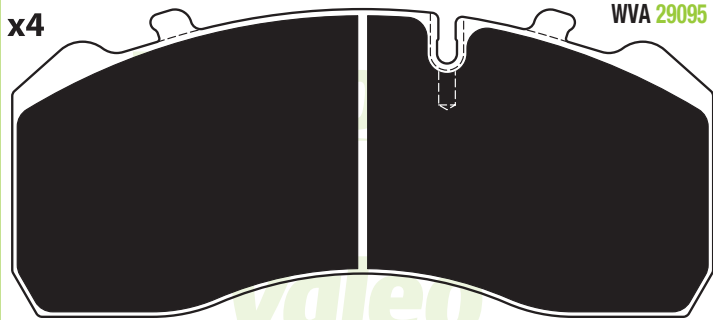

WVA 29095

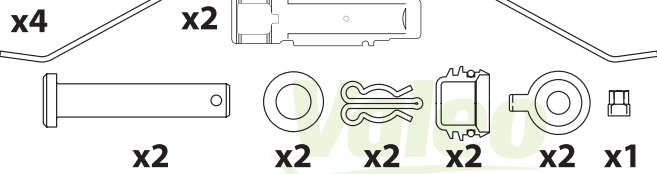

210,4 92,5 30 KNORR SB6 MERCEDES-BENZ Atego 0004210710  
MAN M2000 81508205017

### 187048

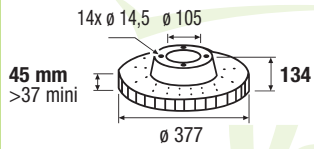

MERCEDES-BENZ OES : 9754210112

### 187084

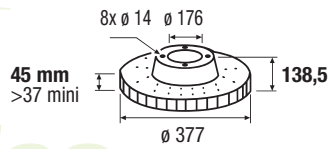

MERCEDES-BENZ OES : 9754230012  
OES : 9754230312

## 882205



WVA 29095

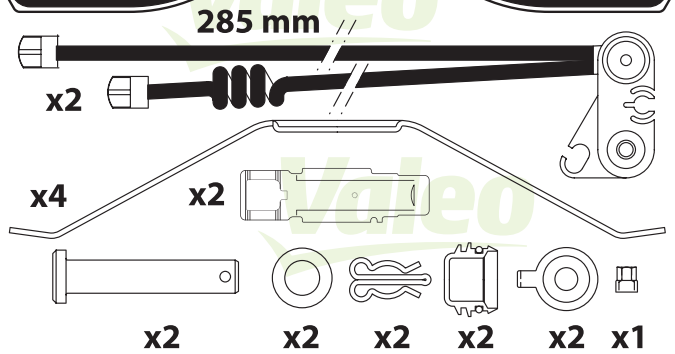

210,4 92,5 30 KNORR SB6 IVECO Eurocargo Tector 2992336 2996468

## 882301



WVA OES

29095 KNORR SB6 1903651

### 187127

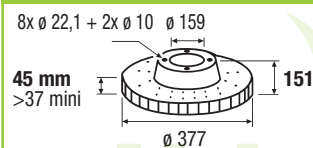

IVECO OES : 2992291

### 187128

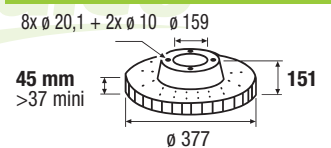

IVECO OES : 2992271

## 882206

WVA 29095

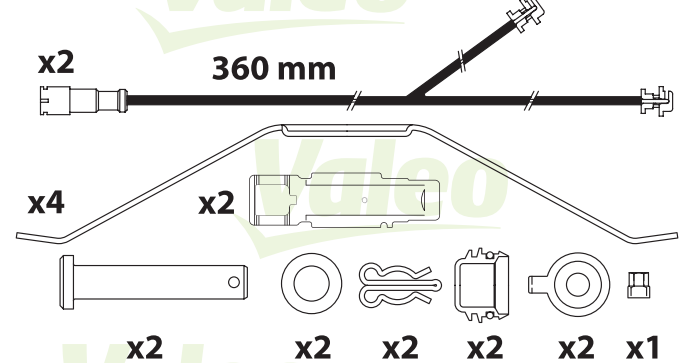
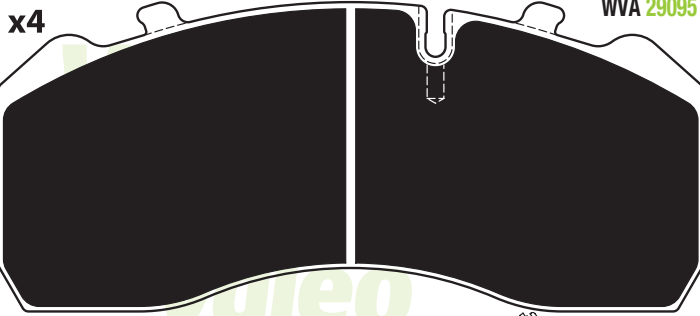

210,4	92,5	30	KNORR SB6	BPW	SB3745	0980102750	0980102930
-------	------	----	-----------	-----	--------	------------	------------

## 882306

x2 360 mm

WVA OES

29095 KNORR SB6

### 187067

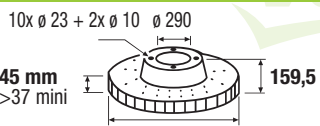

BPW OES : 0308834040  
OES : 0308834047

### 187086

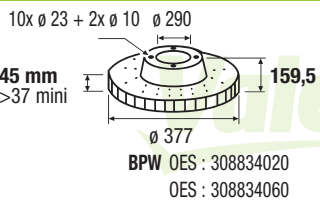

BPW OES : 308834020  
OES : 308834060

### 187104

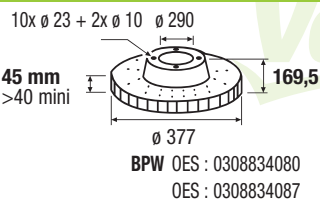

BPW OES : 0308834080  
OES : 0308834087

### 187064

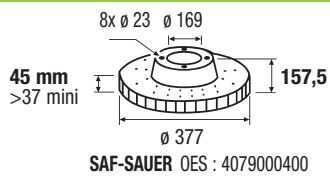

SAF-SAUER OES : 4079000400

### 187096

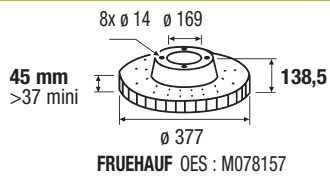

FRUEHAUF OES : M078157

### 187100

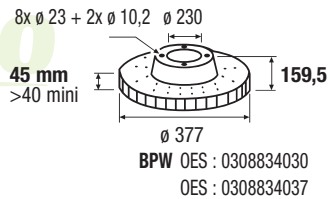

BPW OES : 0308834030  
OES : 0308834037

### 187103

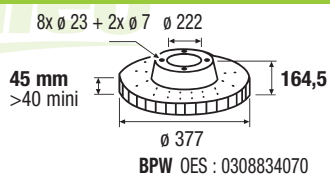

BPW OES : 0308834070

## 882207

WVA 29165

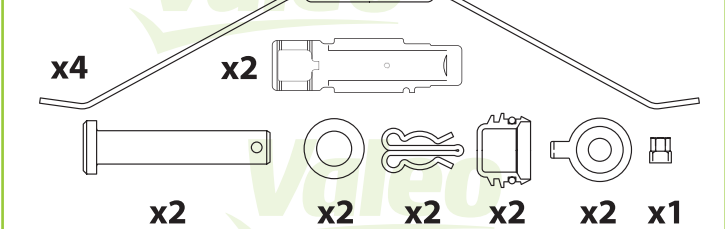
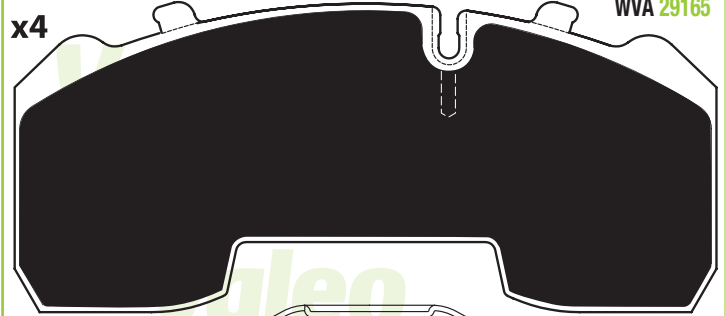

210,4	92,5	30	KNORR SN6	BPW	SB3745	0980106350	0980106430
-------	------	----	-----------	-----	--------	------------	------------

### 187100

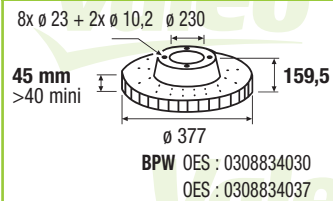

BPW OES : 0308834030  
OES : 0308834037

### 187132

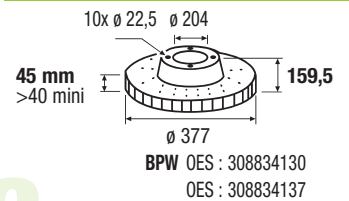

BPW OES : 308834130  
OES : 308834137

882208

WVA 29167

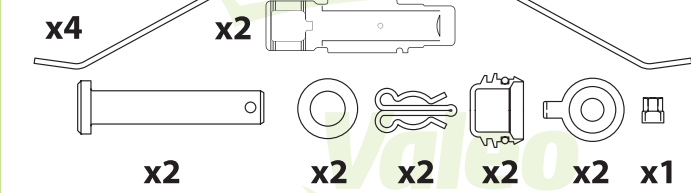
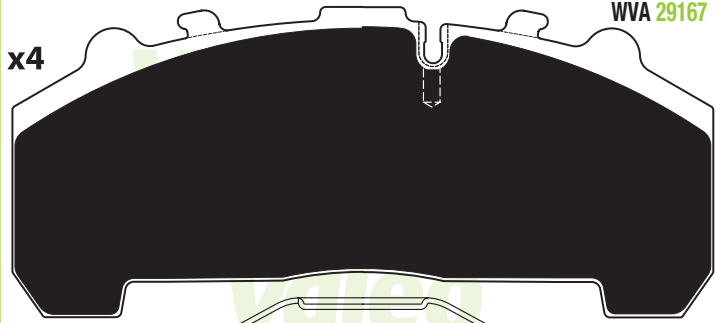

247,4 109,5 30 KNORR SN7 BPW SB4345 0980106960 0980106450

187057

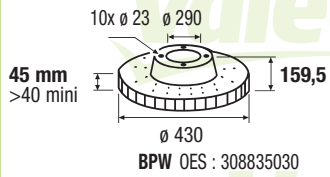

882209

WVA 29171

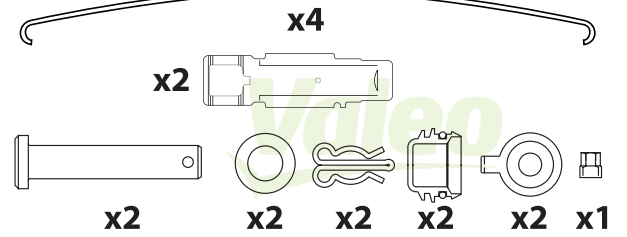
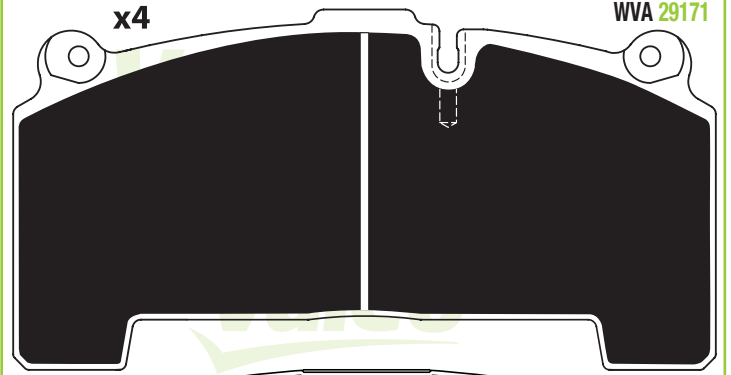

210,2 107,8 30 KNORR SK7 BPW SB4309 0509290060 0980106440

## 882210

WVA 29115

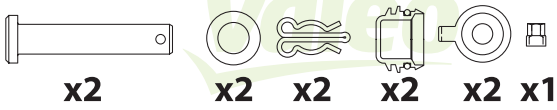

185/173,5 84 34/27 KNORR SB5 MERCEDES-BENZ Atego 0004211010 0004211210

### 187043

10x  $\varnothing$  14,5  $\varnothing$  91,55

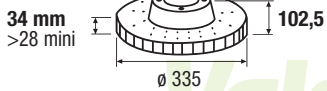

MERCEDES-BENZ OES : 9704210112  
OES : 9704210612

### 187082

8x  $\varnothing$  12  $\varnothing$  145

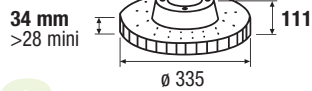

MERCEDES-BENZ OES : 9704230412  
OES : 9704230612

### 187083

8x  $\varnothing$  12  $\varnothing$  152

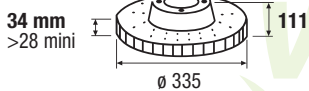

MERCEDES-BENZ OES : 9704230512

### 187137

10x  $\varnothing$  15 + 2x  $\varnothing$  10  $\varnothing$  90

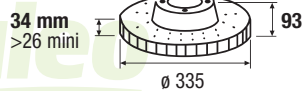

MAN OES : 81508030042

### 187138

10x  $\varnothing$  14 + 2x  $\varnothing$  8  $\varnothing$  125

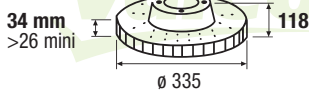

MAN OES : 81508030063

### 187139

10x  $\varnothing$  15  $\varnothing$  90

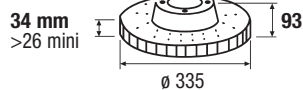

MAN OES : 81508030053

### 187140

10x  $\varnothing$  14 + 2x  $\varnothing$  8  $\varnothing$  125

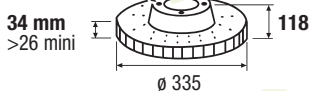

MAN OES : 81508030062

## 882211

WVA 29030

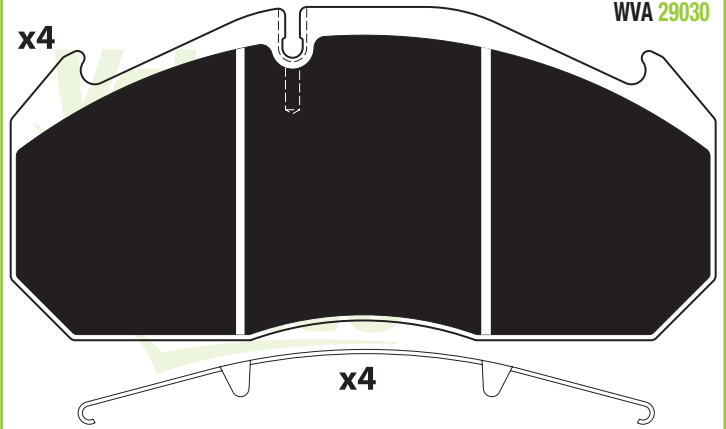

249	118,1	28	LUCAS D3	IRISBUS	Heuliez Agora	5001823000
				RENAULT TRUCKS	Magnum Premium	5001834075

### 187024

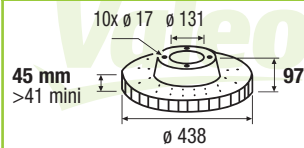

RENAULT TRUCKS OES : 5010216437



## 882212

x4

WVA 29030

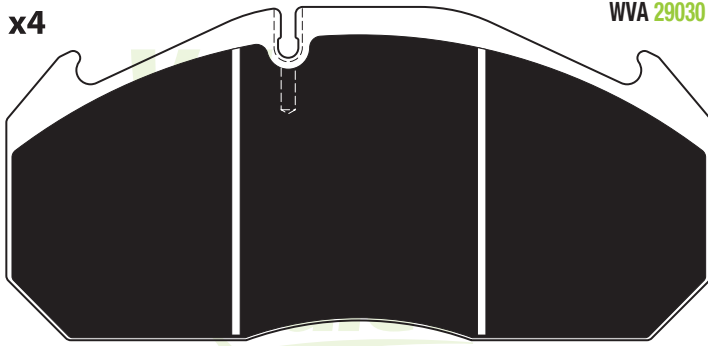

x4

355 mm



x2

249 118,1 28 LUCAS D3 IRISBUS Heuliez 5001823000

249 118,1 28 LUCAS D3 IRISBUS Heuliez 5001823000  
 RENAULT TRUCKS Magnum Premium 5001834075

## 882312

355 mm



x2

WVA OES

29030 LUCAS D3 5001834075

## 187024

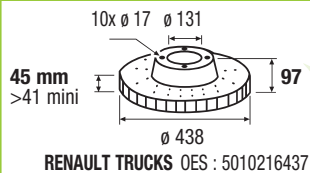

RENAULT TRUCKS OES : 5010216437

## 882213

x4

WVA 29030

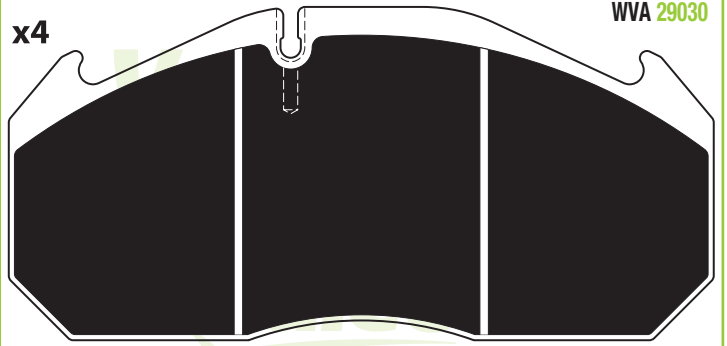

x4

340 / 230 mm



249 118,1 28 LUCAS D3 IRISBUS Heuliez 5001823000

249 118,1 28 LUCAS D3 IRISBUS Heuliez 5001823000  
 RENAULT TRUCKS Magnum Premium 5001834075

## 882313

340 / 230 mm



WVA OES

29030 LUCAS D3 68310622

## 187024

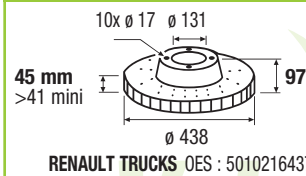

RENAULT TRUCKS OES : 5010216437

## 882214

WVA 29113

x4

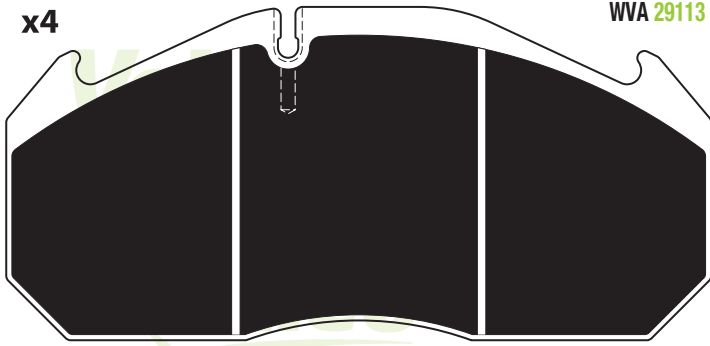

x4



x2

278 / 246 mm



249 118,1 28 LUCAS D-ELSA 1 MAN F90 F2000 M2000 81508205006 81508205021

## 882314



x2

278 / 246 mm

WVA OES

29113 LUCAS D-ELSA 1 68323118

### 187015

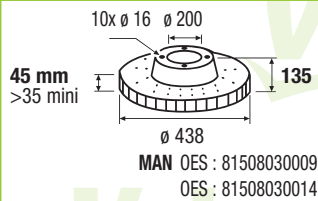

### 187052

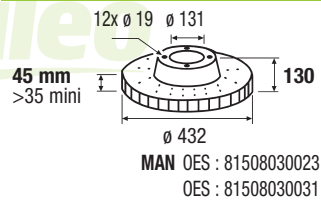

### 187076

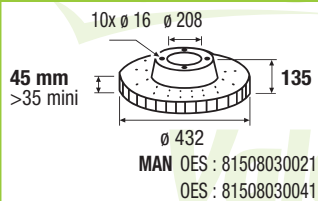

### 187077

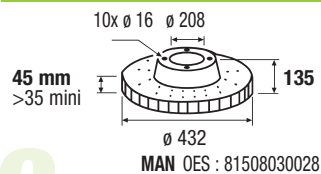

## 882215

WVA 29030

x4

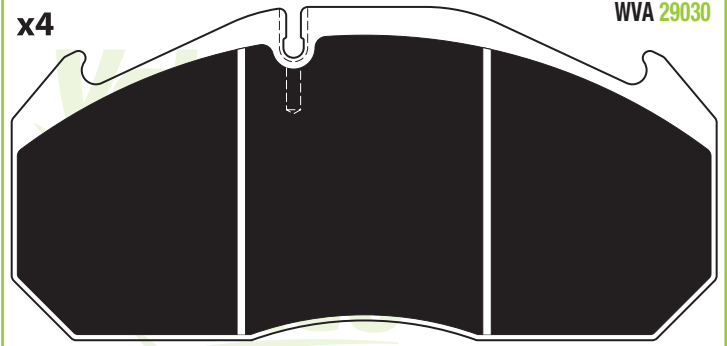

x4



x2

220 / 310 mm



249 118,1 28 LUCAS D3 MERCEDES-BENZ O-Series Integro 0024205520 0034205520

## 882315



x2

220 / 310 mm

WVA OES

29030 LUCAS D3 3565400017

### 187053

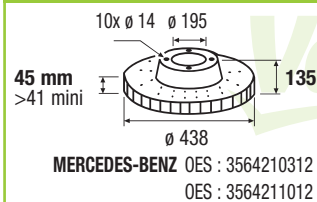

## 882216

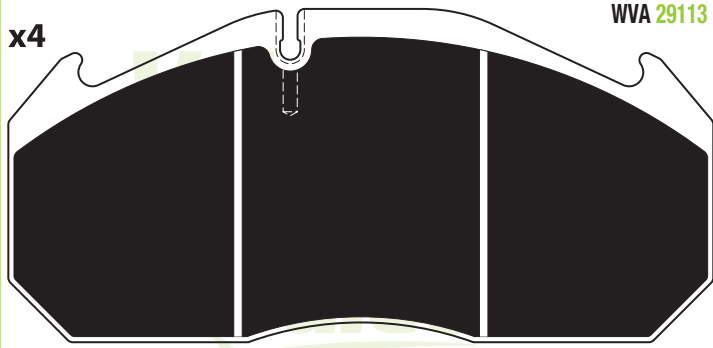

WVA 29113

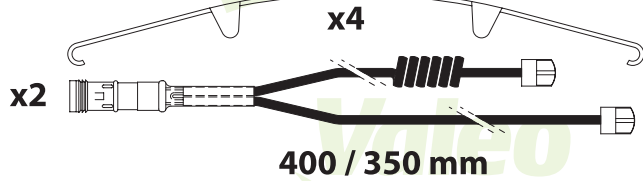

249 118,1 28 LUCAS D-ELSA 1 MAN NG  
NU  
NL Series 81508205066 81508206044

## 882316



WVA OES

29113 LUCAS D-ELSA 1 68323117

### 187052

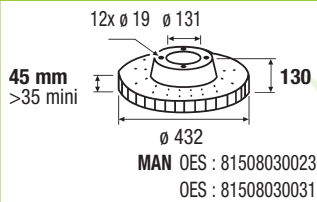

### 187076

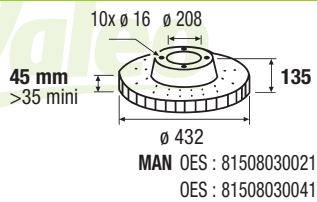

## 882217

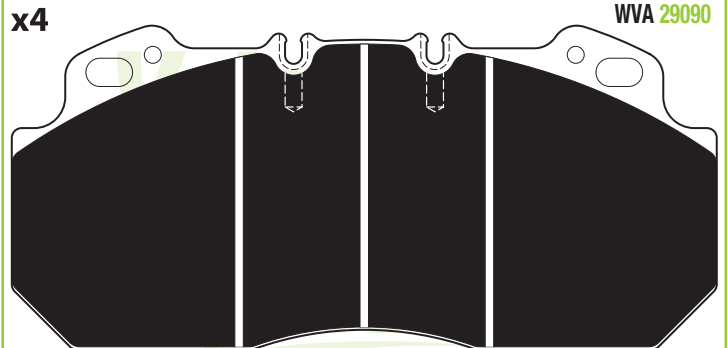

WVA 29090

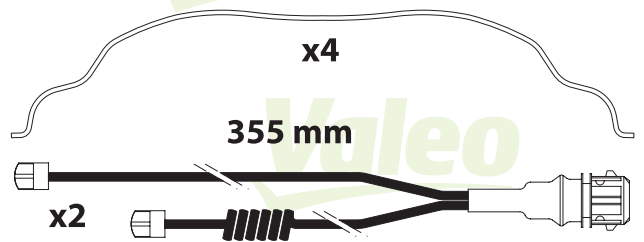

249 109,5 28 LUCAS D-LISA IRISBUS Citelis  
Agora  
Heuliez 5001846034 5001833114

## 882312



WVA OES

29090 LUCAS D-LISA 5001834075

### 187024

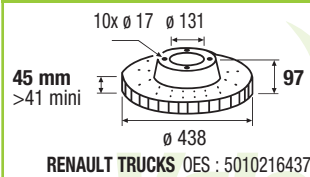

### 187116

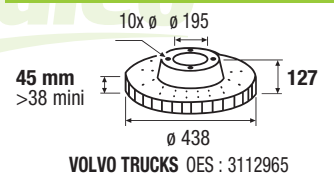

### 882218

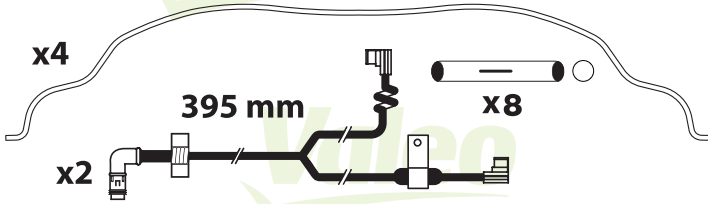
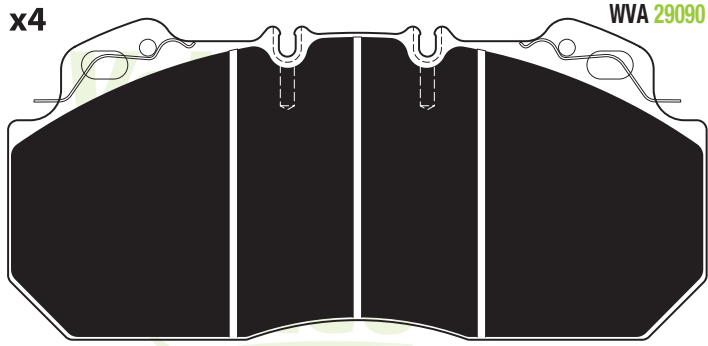

249	109,5	28	LUCAS D-LISA	RENAULT TRUCKS	Magnum Premium	5001846034	5001833114
-----	-------	----	--------------	----------------	----------------	------------	------------

### 882318

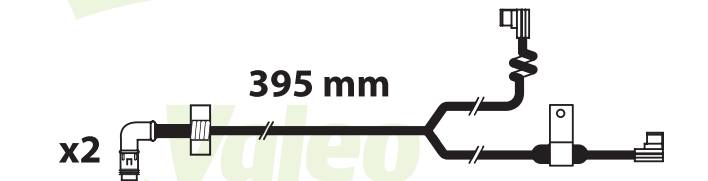

WVA	OES
29090	LUCAS D-LISA 5001831161

### 187024

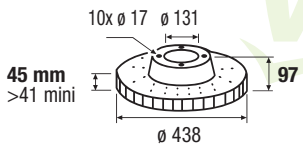

RENAULT TRUCKS OES : 5010216437

### 882219

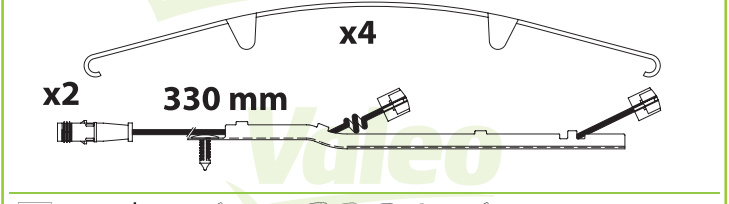
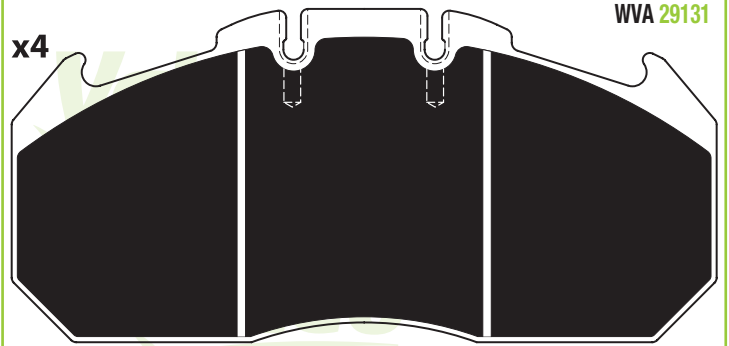

249,3	117,9	30	LUCAS D-ELSA 2	MAN	TGA	81508205072	81508206041
-------	-------	----	----------------	-----	-----	-------------	-------------

### 882319

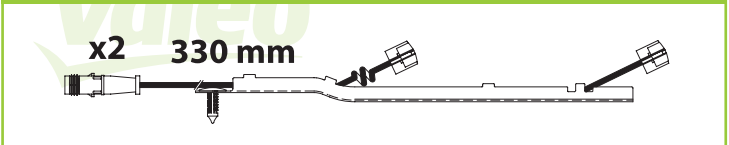

WVA	OES
29131	LUCAS D-ELSA 2 68324072

## 882220

x4

WVA 29131

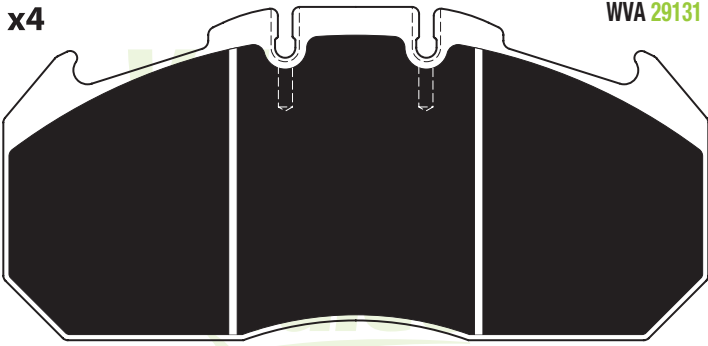

x4

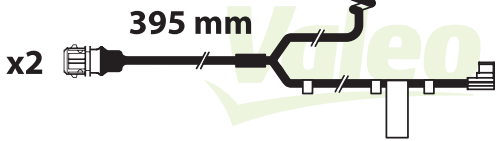

249,3	117,9	30	LUCAS D-ELSA 2	RENAULT TRUCKS	Magnum Premium	5001855646
-------	-------	----	----------------	----------------	----------------	------------

## 882320

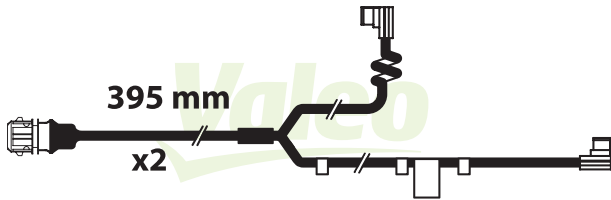

WVA		OES
29131	LUCAS D-ELSA 2	5001834075

### 187024

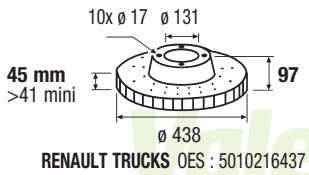

### 187087

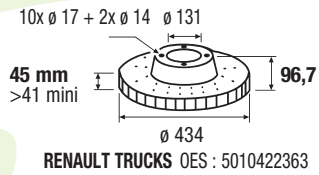

### 187088

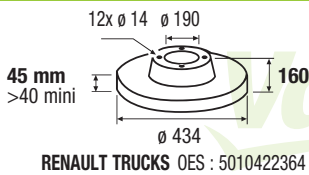

## 882221

x4

WVA 29125

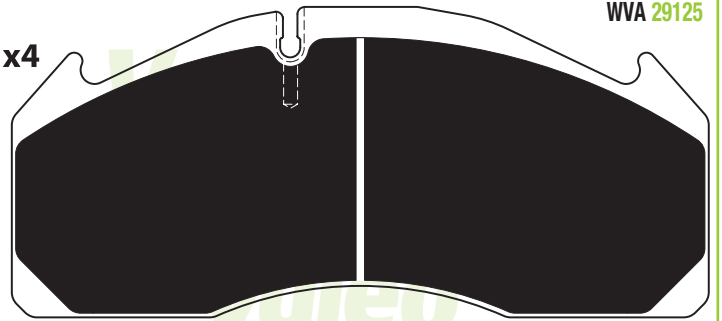

x4

x2

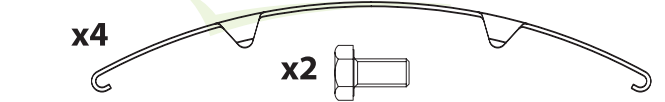

249,1	110,9	29,3	LUCAS D-DUCO	VOLVO TRUCKS	FH 12/16 FM 9/12	OES	1078439	20768092
-------	-------	------	--------------	--------------	---------------------	-----	---------	----------

### 187098

8x ø 24,2 + 2x ø 12 ø 167

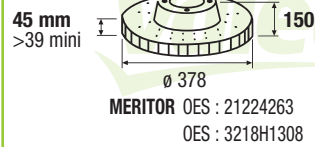

## 882222

x4

WVA 29124

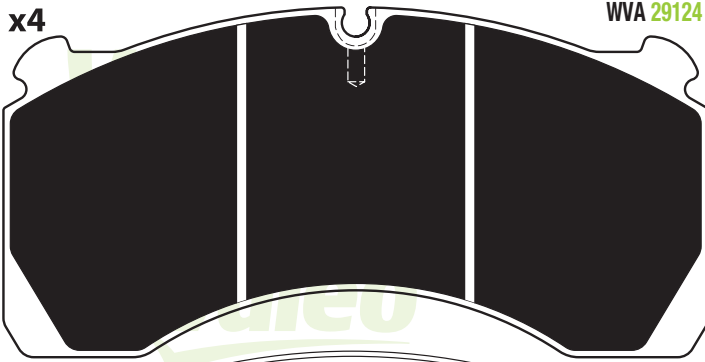

x4

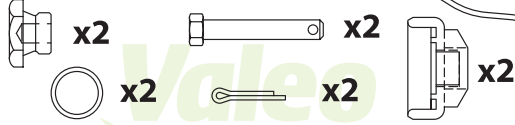

205,3 102 27 MERITOR MERITOR DX195 MDP5076 MDP1314

### 187021

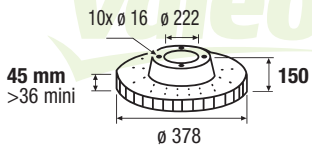

MERITOR OES : 21225115  
OES : 31788700100

## 882223

x4

WVA 29088

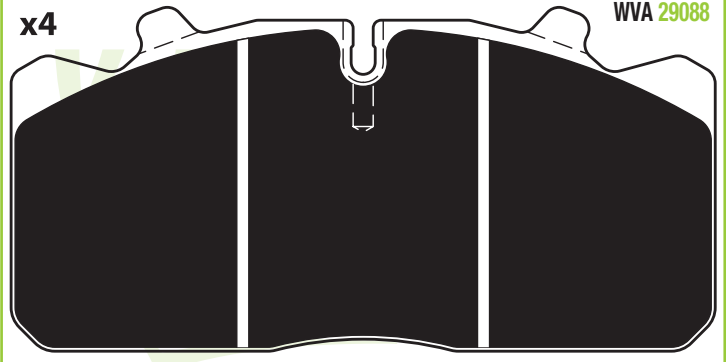

x6

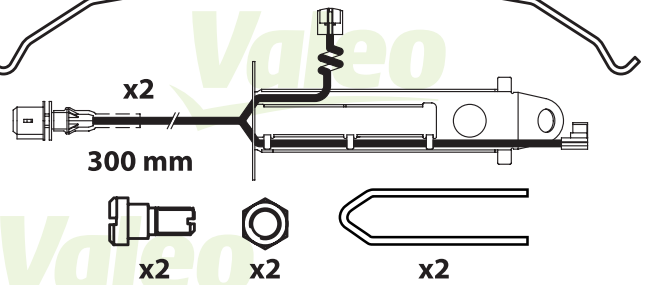

175,3 82,4 26 PERROT PAN 17 RENAULT TRUCKS Midlum 5010848607

## 882323

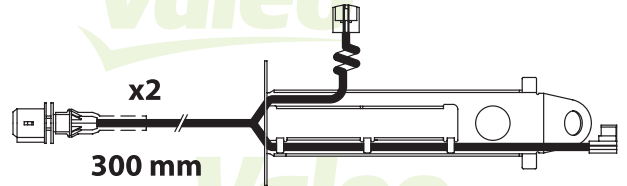

WVA 29088 PERROT PAN 17 OES 5010848607

### 187090

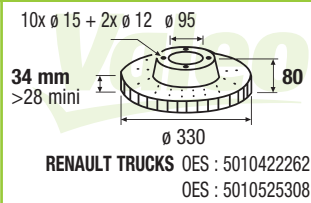

RENAULT TRUCKS OES : 5010422262  
OES : 5010525308

### 187091

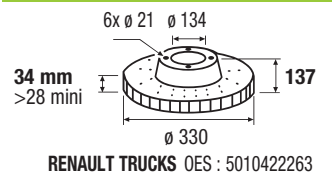

RENAULT TRUCKS OES : 5010422263

### 187092

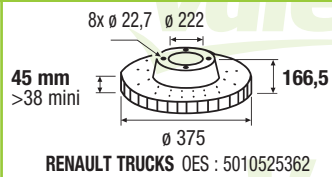

RENAULT TRUCKS OES : 5010525362

### 187093

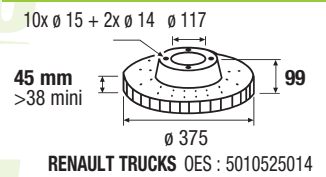

RENAULT TRUCKS OES : 5010525014

### 882224

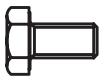
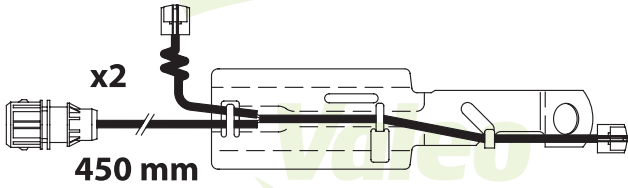
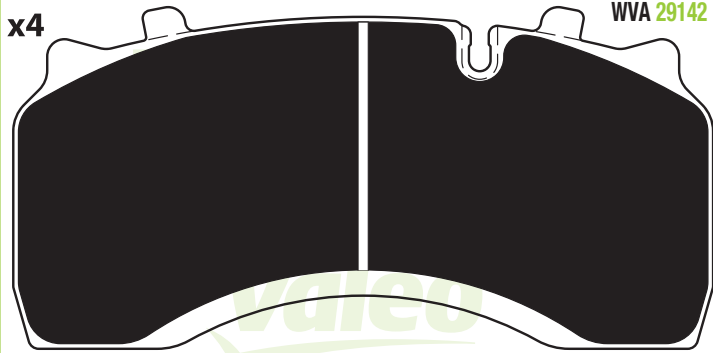

x2



x4

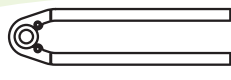

x2



204,5 97 29,9 PERROT PAN 19-2 RENAULT TRUCKS Midlum 5001855902

### 882324

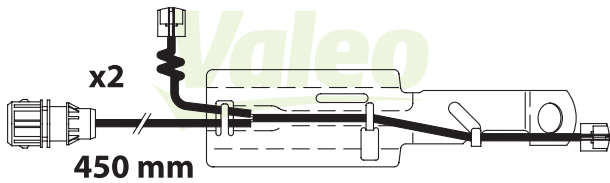

WVA OES

29142 PERROT PAN 19-2

#### 187050

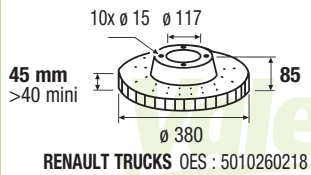

RENAULT TRUCKS OES : 5010260218

#### 187090

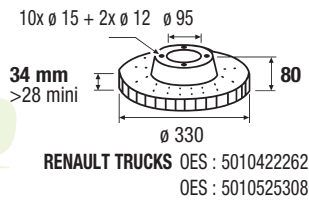

RENAULT TRUCKS OES : 5010422262  
OES : 5010525308

#### 187091

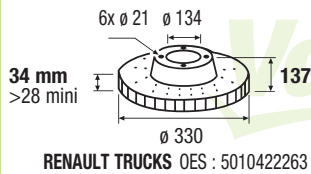

RENAULT TRUCKS OES : 5010422263

### 882225

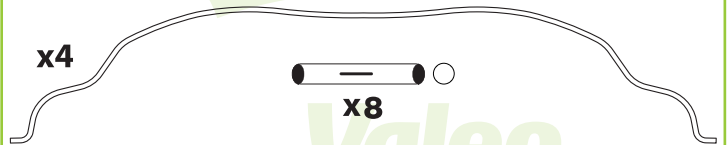
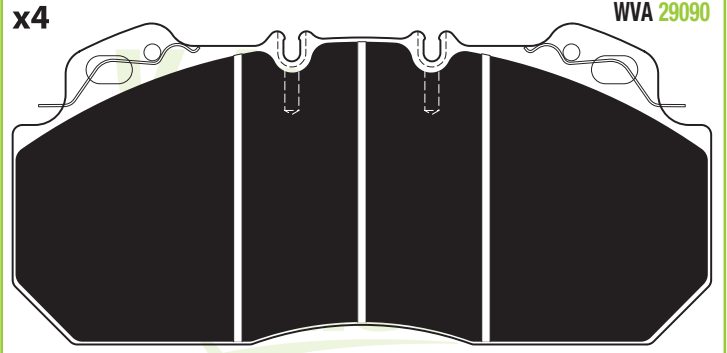

249 109,5 28 LUCAS D-LISA RENAULT TRUCKS Magnum Premium 5001846034 5001833114

#### 187024

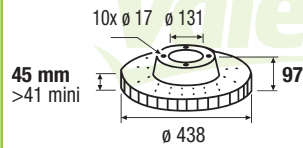

RENAULT TRUCKS OES : 5010216437



## 882226

x4

WVA 29131

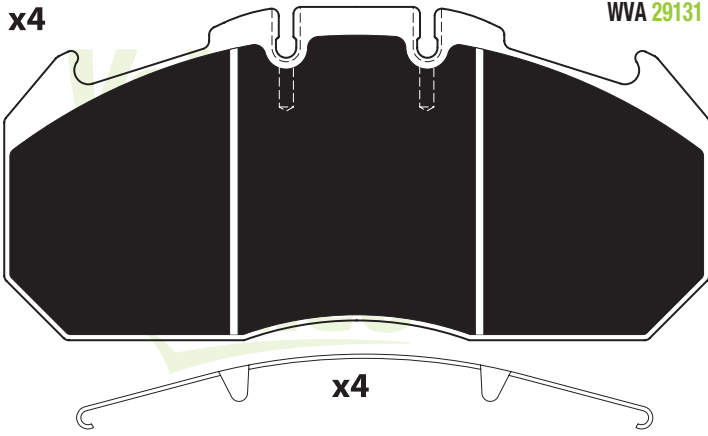

										OES
249,3	117,9	30	LUCAS D-ELSA 2	RENAULT TRUCKS	Magnum Premium	5001855646	5001020312			

### 187024

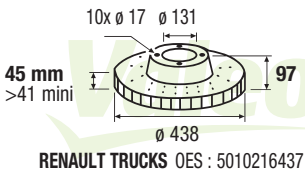

RENAULT TRUCKS OES : 5010216437

### 187087

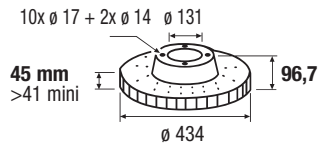

RENAULT TRUCKS OES : 5010422363

### 187088

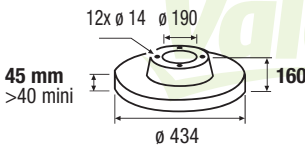

RENAULT TRUCKS OES : 5010422364

## 882227

x4

WVA 29159

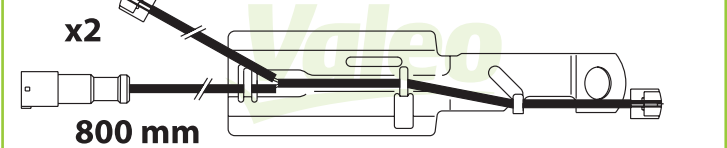
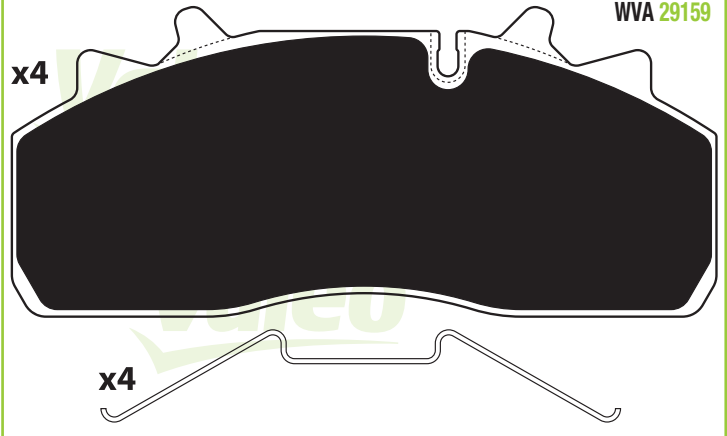

										OES
210,2	79,6	30	PERROT PAN 19-1	DAF	LF 55	1628064				

## 882327

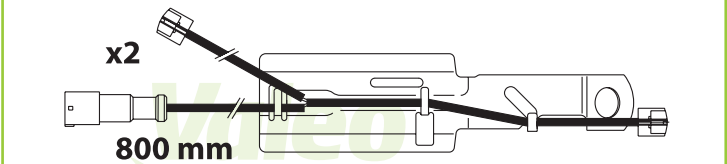

WVA OES

29159 PERROT PAN 19-1

### 187117

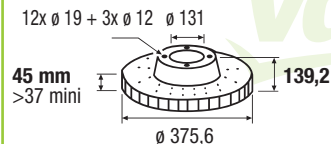

SAF-SAUER OES : 4079000700

### 187134

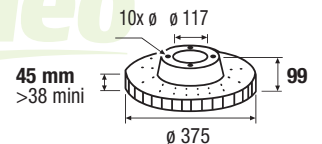

DAF OES : 1400069

### 187135

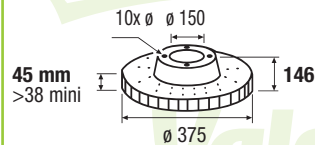

DAF OES : 1400284

## 882228

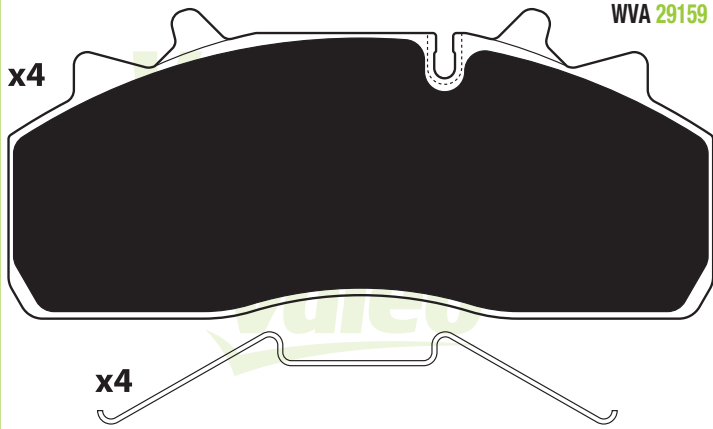

210,2 79,6 30 PERROT PAN 19-1 DAF LF 55 1628064

### 187117

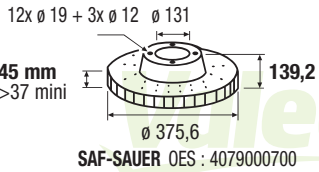

### 187134

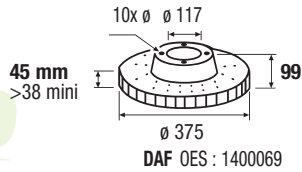

### 187135

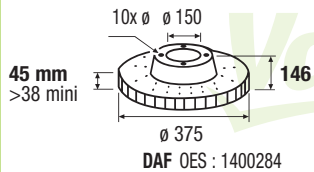

## 882229

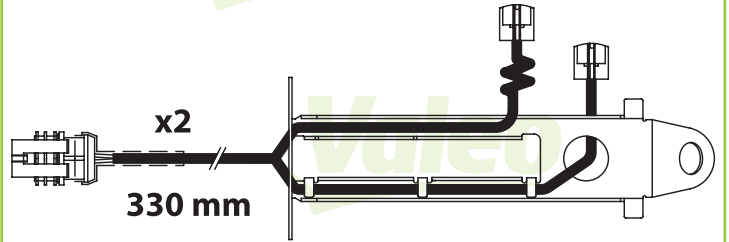
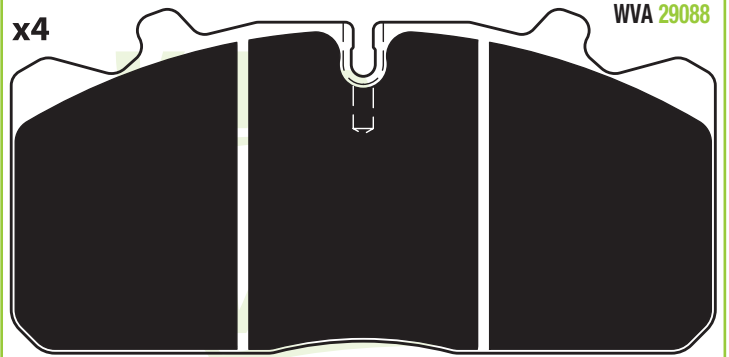

175,3 82,4 26 PERROT PAN 17 DAF LF 45 1436901  
 IVECO Eurocargo Tector 1906467

## 882329

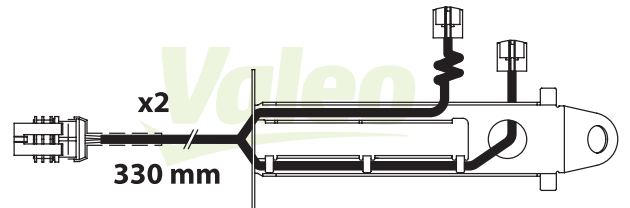

WVA OES

29088 PERROT PAN 17

### 187129

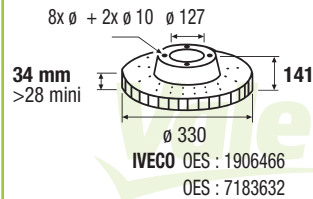

### 187143

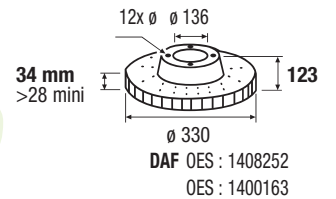

### 187144

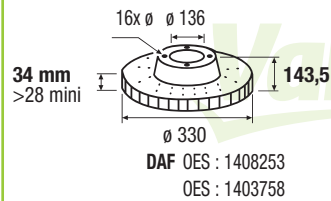

### 187145

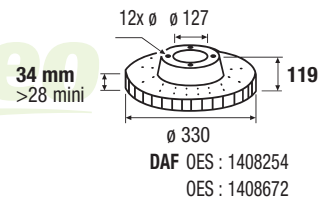

## 882230

WVA 29088

x4

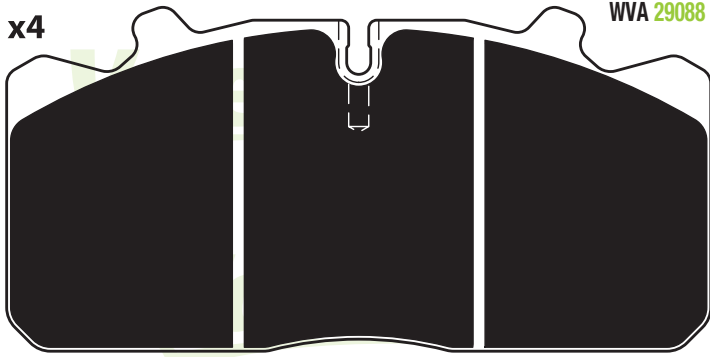

175,3	82,4	26	PERROT PAN 17	DAF	LF 45	1436901
				IVECO	Eurocargo	1906467
				RENAULT TRUCKS	Midlum	5010848607
				MAN	L2000	81508205023
					M2000	

### 187129

8x  $\emptyset$  + 2x  $\emptyset$  10  $\emptyset$  127

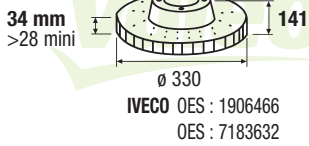

### 187143

12x  $\emptyset$   $\emptyset$  136

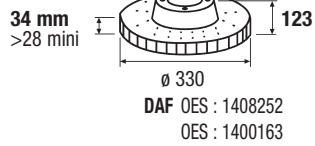

### 187144

16x  $\emptyset$   $\emptyset$  136

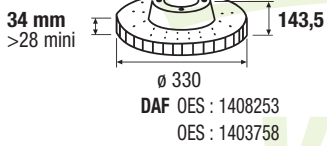

### 187145

12x  $\emptyset$   $\emptyset$  127

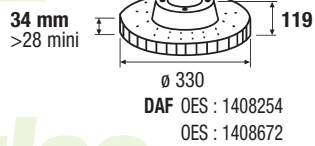

## 882231

WVA 29011

x4

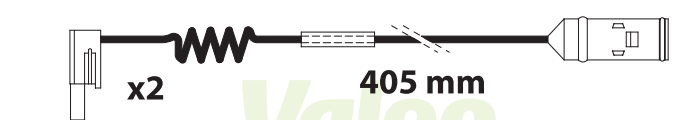
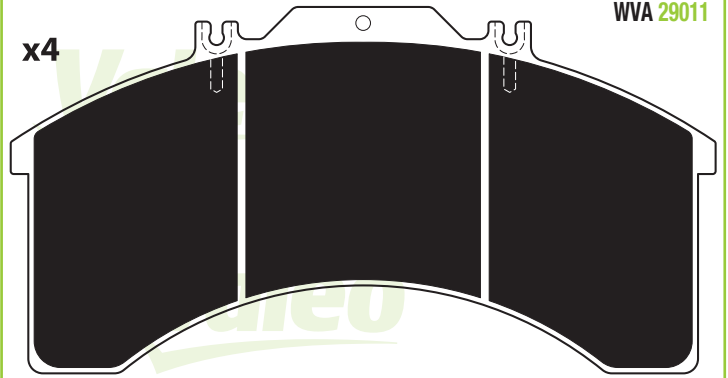

240,6	124,6	25	BENDIX	IVECO	Eurocargo	1906191	1906459
					Eurostar		
					Eurotech		

## 882331

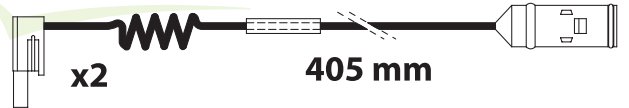

WVA OES

29011 BENDIX 1907956

### 187089

12x  $\emptyset$   $\emptyset$  170

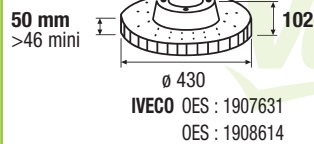

## 882232

WVA 29011

x4

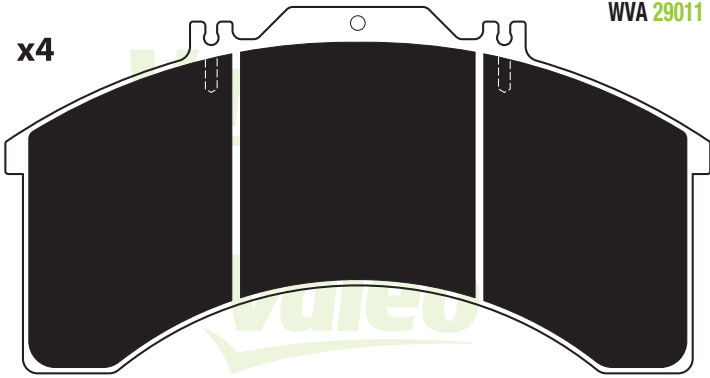

240,6 124,6 25 BENDIX IVECO Eurocargo Eurostar Eurotech 1906191 1906459

## 187089

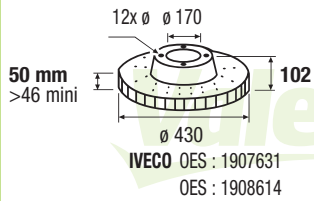

## 882233

WVA 29122

x4

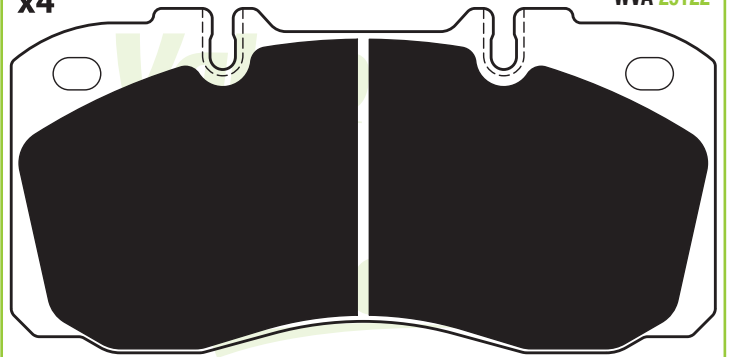

475 mm

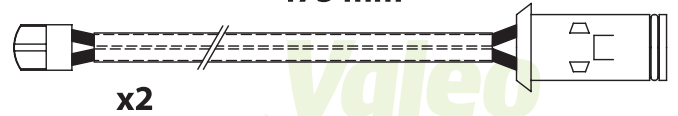

175 79,5 22 BREMBO IVECO Eurocargo 1906416 1906298

## 882333

475 mm

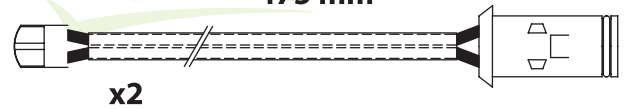

WVA 29122 BREMBO IVECO 1908825

## 187059

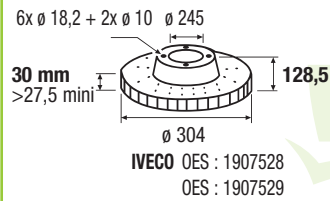

### 882234

x4

WVA 29122

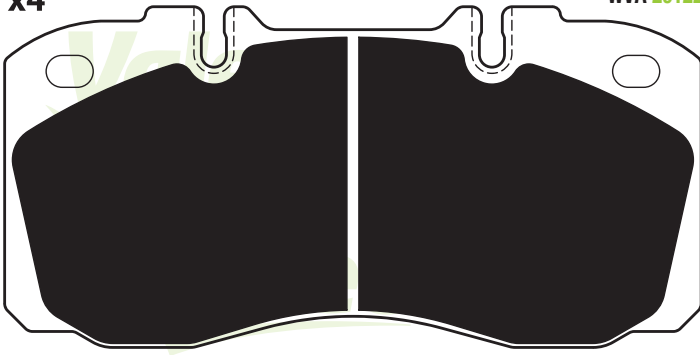

x2

295 mm



175	79,5	22	BREMBO	IVECO	Eurocargo Eurocargo Tector	1906416	1906298
-----	------	----	--------	-------	-------------------------------	---------	---------

### 882334

x2

295 mm



WVA	OES
29122	BREMBO 1908407

### 187059

6x  $\varnothing$  18,2 + 2x  $\varnothing$  10  $\varnothing$  245

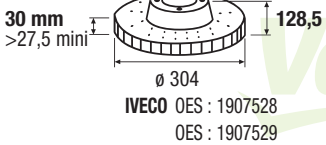

IVECO OES : 1907528  
OES : 1907529

### 882235

x4

WVA 29122

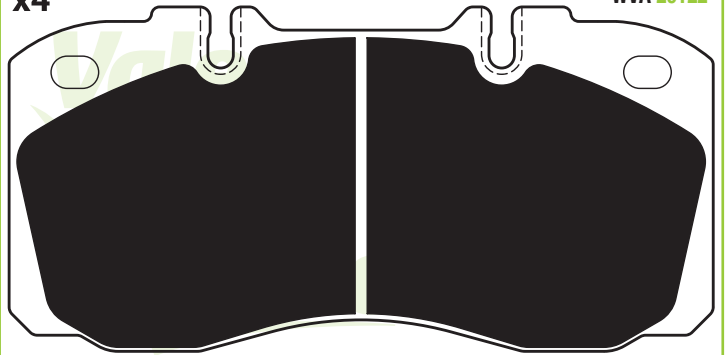

175	79,5	22	BREMBO	IVECO	Eurocargo Eurocargo Tector	1906416	1906298
-----	------	----	--------	-------	-------------------------------	---------	---------

### 187059

6x  $\varnothing$  18,2 + 2x  $\varnothing$  10  $\varnothing$  245

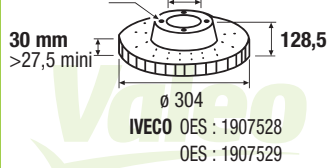

IVECO OES : 1907528  
OES : 1907529

## 882236

x4

WVA 29067

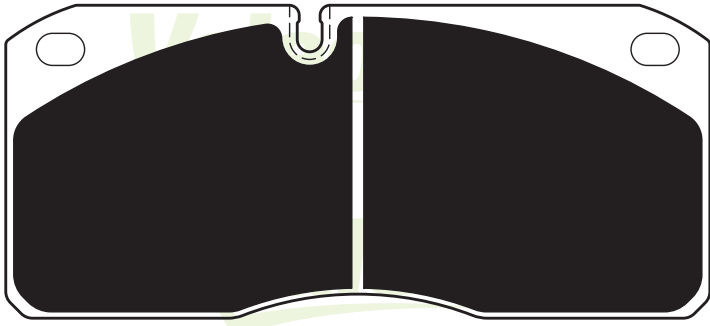

295 mm



x2

x4



x4

										OES
176	78	22	LUCAS	IVECO	Eurocargo	1906043	1906297			

## 882334

x2

295 mm



WVA



OES

29067

LUCAS

1906462

### 187005

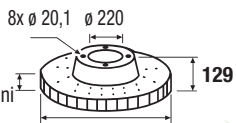

IVECO OES : 1907765  
OES : 7171255

### 187006

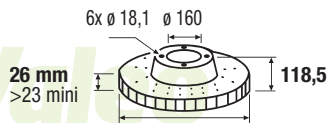

IVECO OES : 1904532  
OES : 7168368

### 187060

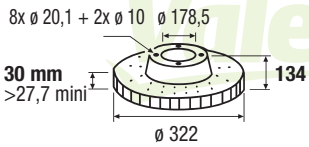

IVECO OES : 1907526  
OES : 1907527

## 882237

x4

WVA 29011

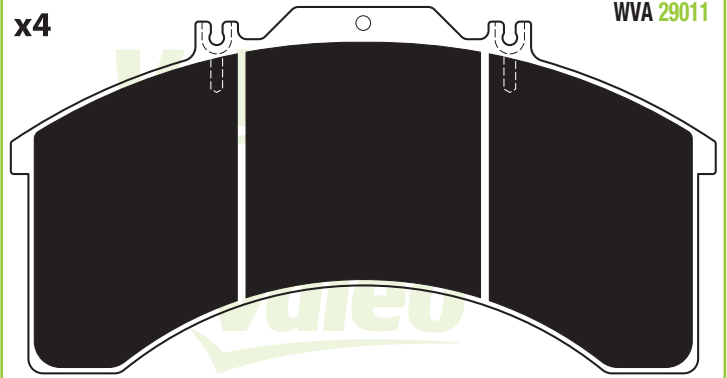

430 mm



x2



240,6	124,6	25	BENDIX	IVECO	Eurocargo Eurostar Eurotech	1906191	1906459
-------	-------	----	--------	-------	-----------------------------------	---------	---------

## 882337

x2

430 mm



WVA



OES

29011

BENDIX

1908231

### 187089

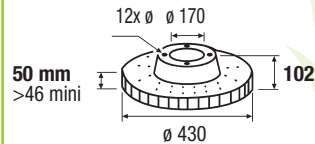

IVECO OES : 1907631  
OES : 1908614

## 882238

x4

WVA 29088

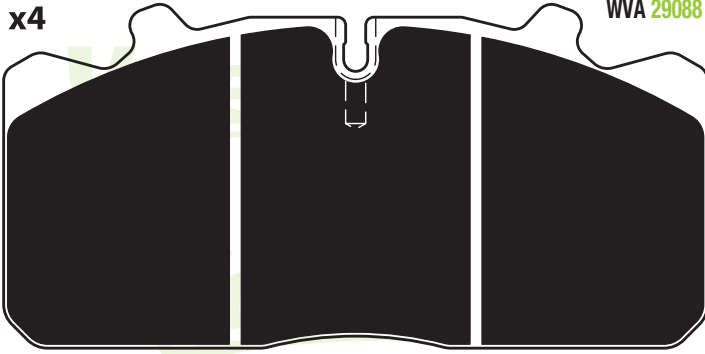

x2

295 mm

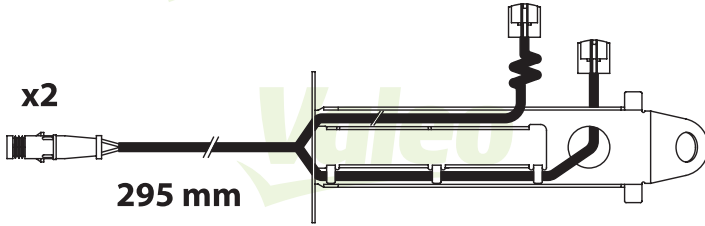

175,3 82,4 26 PERROT PAN 17 MAN L2000 M2000 81508206006

## 882338

x2

295 mm

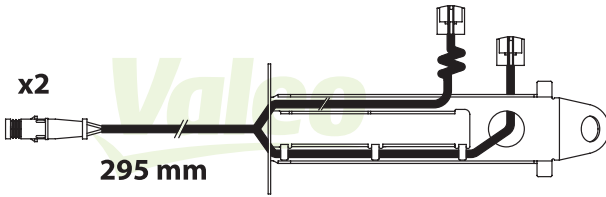

WVA OES

29088 PERROT PAN 17 81508226014

### 187014

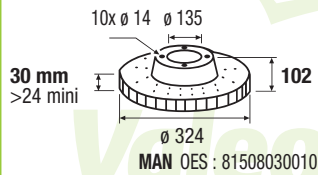

### 187049

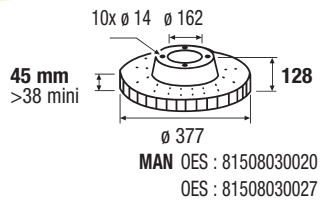

### 187056

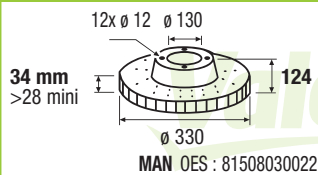

### 187065

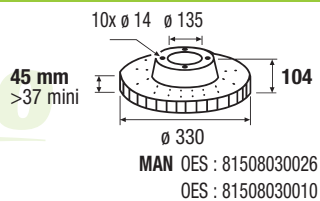

## 882239

x4

WVA 29835

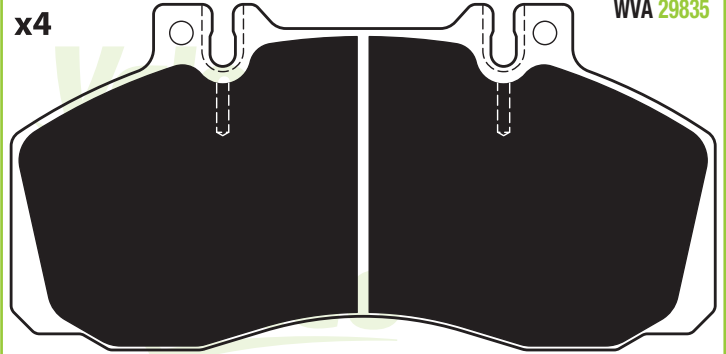

220 / 310 mm

x2



175 85,5 22 LUCAS MERCEDES-BENZ Vario Medio Sprinter 0014201520 0024205720

## 882339

220 / 310 mm

x2



WVA OES

29835 LUCAS 6695400917

### 187105

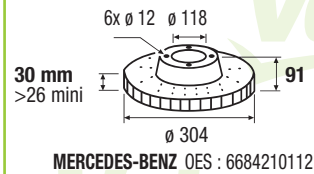

### 187106

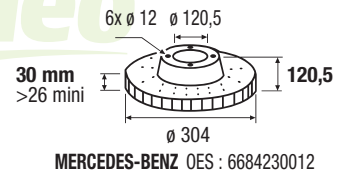

### 187107

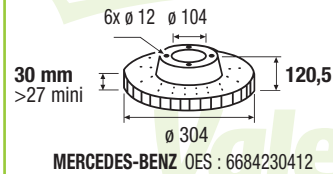

### 187108

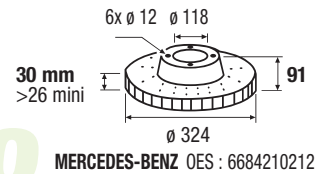

### 187109

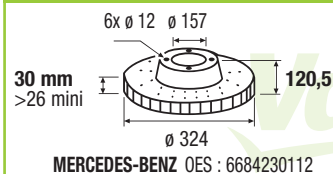

### 187110

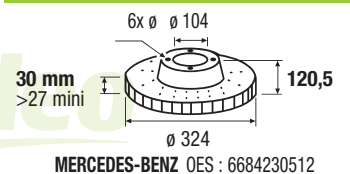

## 882240

x4

WVA 29835

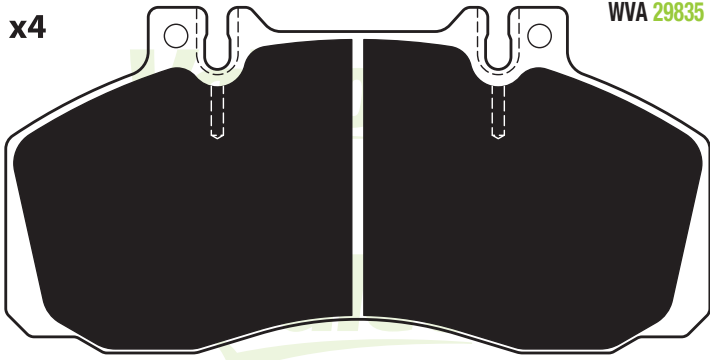

175 85,5 22 LUCAS MERCEDES-BENZ Vario Medio Sprinter 0014201520 0024205720

### 187105

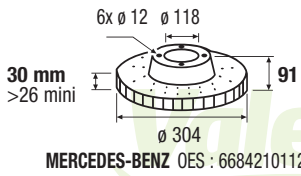

### 187106

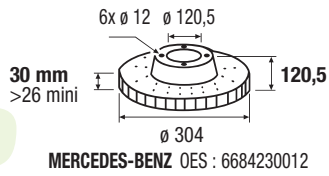

### 187107

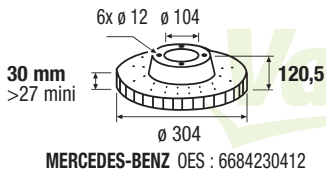

### 187108

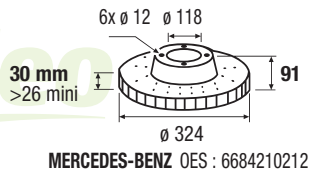

### 187109

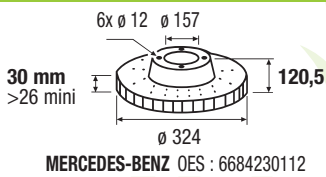

### 187110

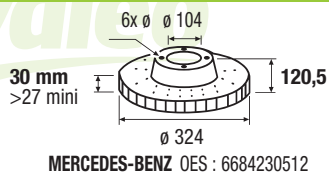

## 882241

x4

WVA 29065

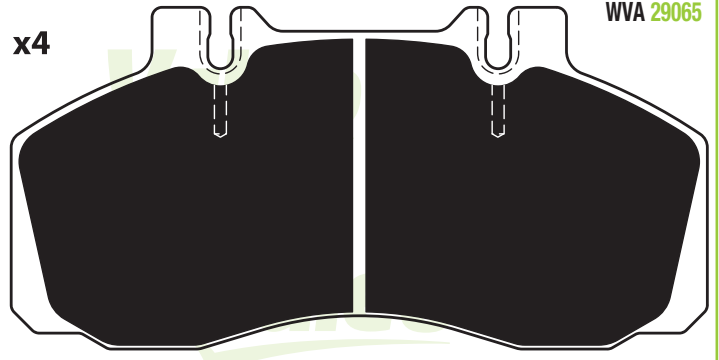

x2

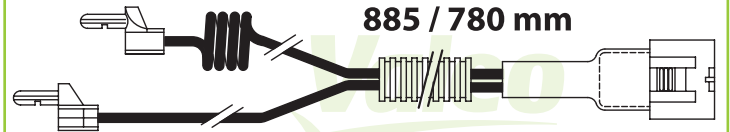

175 85,5 22 LUCAS RENAULT TRUCKS Midliner S 5001014694 5001825638

## 882341

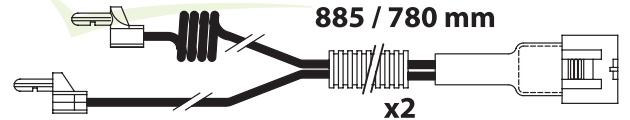

WVA 29065 LUCAS 68320874

### 187044

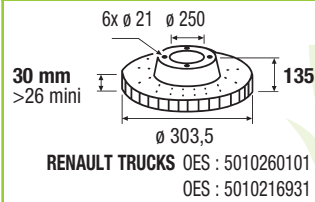





## 882244

x4

WVA 29173

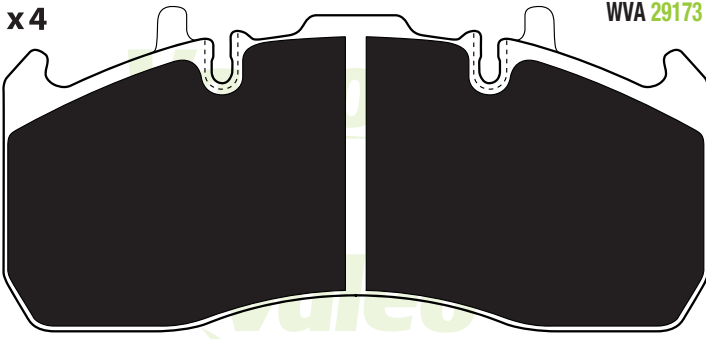

x4

x2



216	96,5	29,25	ELSA 225-1	RENAULT TRUCKS Midlum	5001864365
				VOLVO TRUCKS FL II	20568712 20568715

## 187090

10x  $\varnothing$  15 + 2x  $\varnothing$  12  $\varnothing$  95

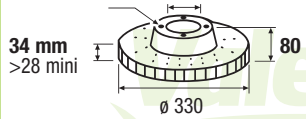

RENAULT TRUCKS OES : 5010422262  
OES : 5010525308

## 882245

x4

WVA 29174

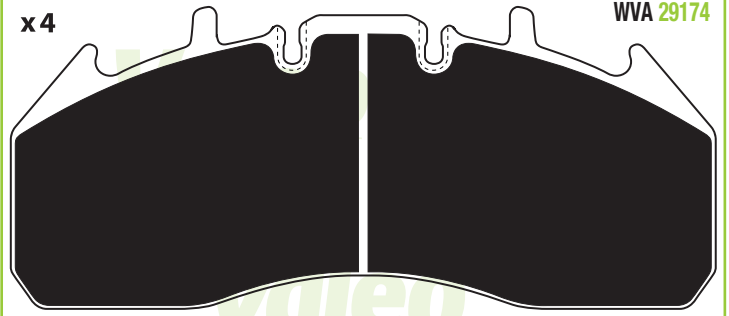

x2

x4

x2



249,6	107	29,25	ELSA 225-3	RENAULT TRUCKS Magnum DXi Premium DXi	5001864364 5001864363
				VOLVO TRUCKS FH/FE/FM	20568711 20568714

## 882345

x2

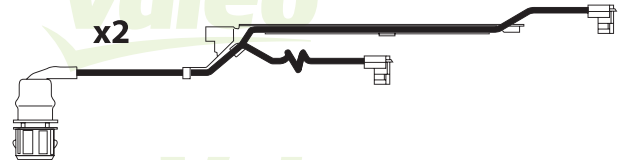

WVA OES

29174 ELSA 225-3 5001834075



882248

x4

WVA 29177



x4

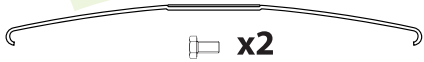

x2



OES

210,5 99,7 29,25

VGT195

RENAULT TRUCKS Magnum DXi  
Premium DXi

5001864380

VOLVO TRUCKS FH

20568713 20765963

882249

x4

WVA 29181

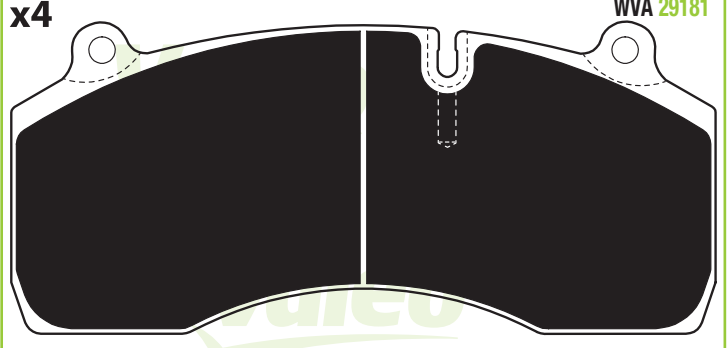

x4



x2



x2

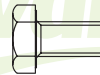

OES

210 92 30

HALDEX DB19

RENAULT TRUCKS Midlum

5001866914

Valeo

Valeo

Valeo

Valeo

Valeo

Valeo

Valeo

Valeo

Valeo

Valeo

Valeo

Valeo

882250

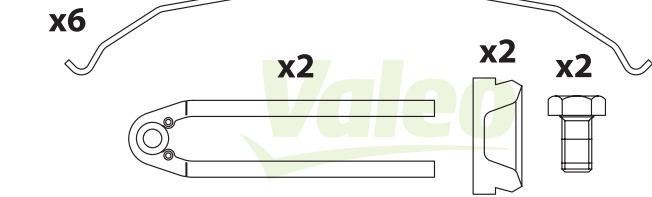

210,5 104,3 31 PERROT PAN 22-1 SAF-SAUER 3057008400

187072

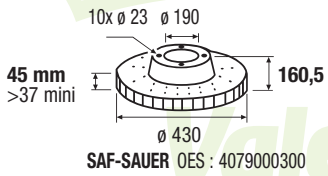

187074

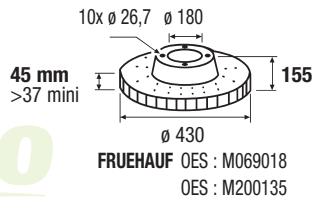

187075

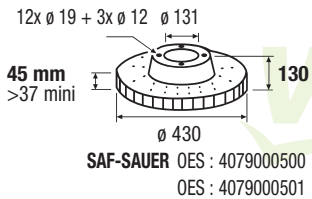

882251

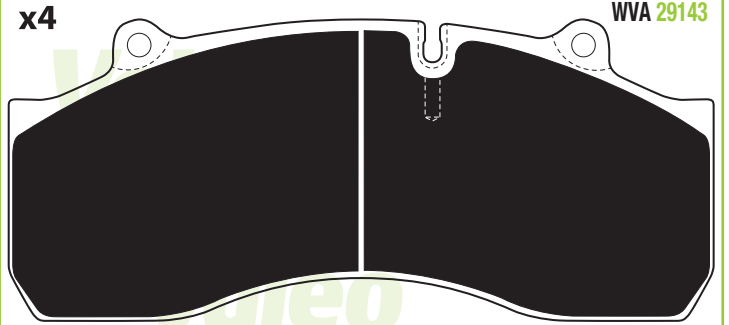

247,4 105 30 HALDEX DB22 SAF-SAUER 9291063

Valeo

Valeo

Valeo

Valeo

Valeo

Valeo

# 882254

x4

WVA 29067

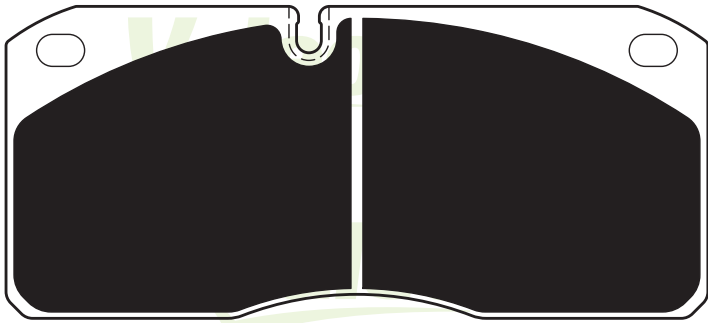

176 78 22 LUCAS RENAULT TRUCKS Midliner S 5001014704

## 187005

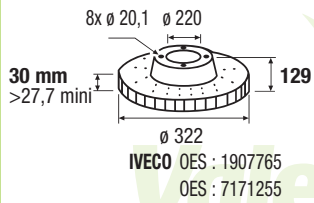

## 187006

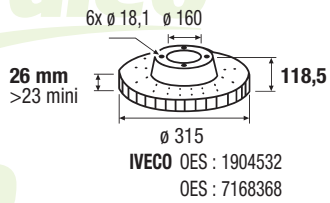

## 187060

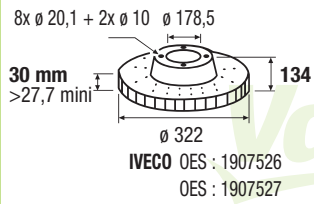

# 882255

x4

WVA 29067

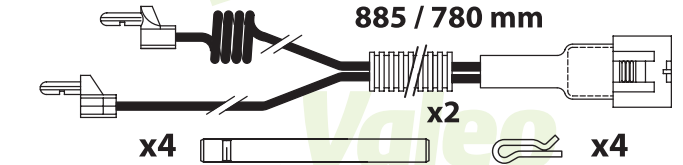
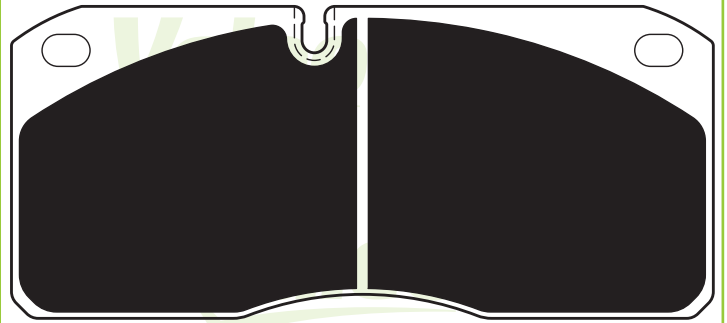

176 78 22 LUCAS RENAULT TRUCKS Midliner S 5001014704

# 882341



WVA CES

29067 LUCAS 68320874

## 187063

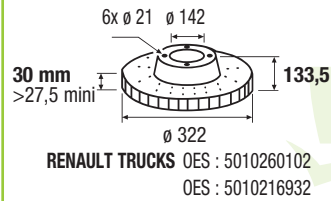

## 882257

WVA 29039

x4

400 mm

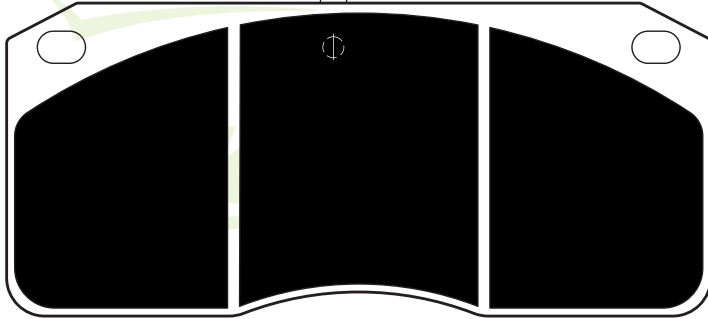

x4

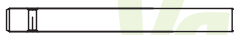

x4



175	78	22	LUCAS	FORD	Cargo	6171272	
				VOLVO TRUCKS	FL 6	3090048	2709012

### 187002

### 187026

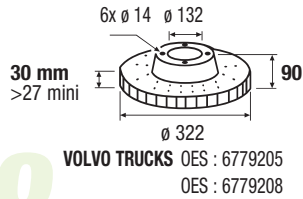
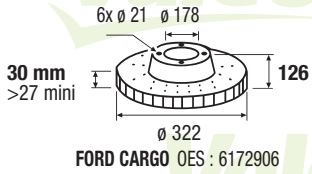

### 187027

### 187055

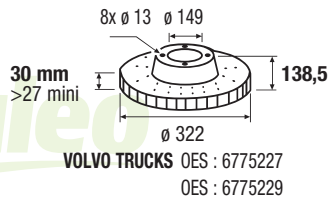
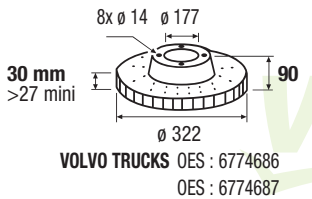

### 187085

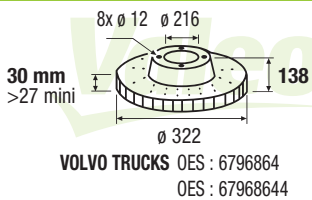

## 882258

WVA 29067

x4

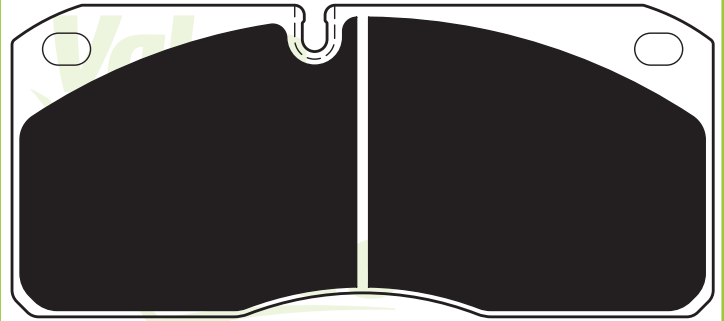

x2

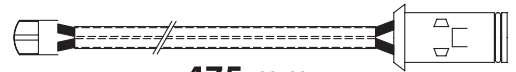

475 mm

x4

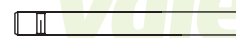

x4



176	78	22	LUCAS	IVECO	Eurocargo	1906043	1906297
-----	----	----	-------	-------	-----------	---------	---------

## 882333

475 mm

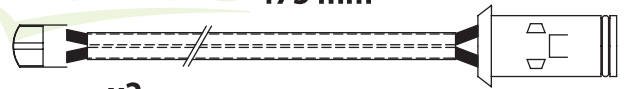

x2

WVA OES

29067 LUCAS

### 187005

### 187006

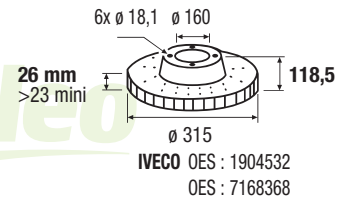
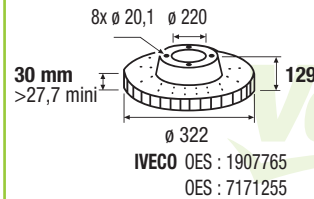

### 187060

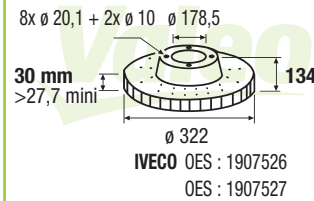







































































































# OptiPACK™

<b>Valeo</b>	<b>WVA</b>	<b>TEXTAR</b>	<b>FERODO</b>	<b>ABEX</b>	<b>BERAL</b>	<b>JURID</b>
882200	29087	2920202	FCV1373BFE	G6843FE	2917930004145504	2910815390
882201	29087	2919670	FCV1373BFE+FAI160	G6843FE+FAI160	2917930004145504+UAI160	2910815390 +
882202	29087	2920202+98025400(P8535)	FCV1373BFE+FAI141	G6843FE+FAI141	2917930004145504+UAI141	2910815390 +
882203	29087	2920202+98028900(P8548)	FCV1328BFE+FAI137	G6841FE+FAI137	2917930004145694	2910815390 +
882204	29095	2909504	FCV1275BFE	G6746FE	2919730004145504	2909305390
882205	29095	2909504+98025300(P8534)	FCV1275BFE+FAI160	G6746FE+FAI160	2919730004145504+UAI160	2909305390 +
882206	29095	2909504+98028800(P8547)	FCV1329BFE+FAI136	G6813FE+FAI136	2919730004145504+UAI136	2909305390 +
882207	29165	2916503	FCV1678B	G6938	2916530004145754	
882208	29167	2916702	FCV1677B	G6937	2916730004145754	
882209	29171	2917103	FCV1825B	G6939	2917130004145754	
882210	29115	2914812	FCV1277BFE	G6796FE	2918327004145503	
882211	29030	2903007	FCV1585BFE	G6898FE	2921028004145724	2903005390
882212	29030	2903007+98031900	FCV1585BFE+FAI101	G6898FE+FAI101	2921028004145724+UAI101	2903005390 +
882213	29030	2903071	FCV1585BFE+FAI165	G6898FE+FAI165	2921028004145724+UAI165	2903005390 +
882214	29113	2911303+98024300(P8521)	FCV1578BFE+FAI161	G6912+FAI161	2921028004145684+UAI161	2903005390 +
882215	29030	2908302+98017600(P8506)	FCV1762BFE+FAI108	G6930+FAI108	2921028004145504+UAI108	2903005390 +
882216	29113	2911303+98024300(P8521)	FCV1585BFE+FAI161	G6898FE+FAI161	2921028004145724+UAI161	2903005390 +
882217	29090	2909006+98031900	FCV1047B+FAI101	G6644+FAI101	2909028004145724+UAI101	2909005392 +
882218	29090	2909071	FCV1047B+FAI116	G6644+FAI116	2909028004145724+UAI116	2909005392 +
882219	29131		FCV1404BFE+FAI164	G6920FE+FAI164	2915630004145684+UAI164	2913109560 +
882220	29131	2913171	FCV1404BFE+FAI163	G6921FE+FAI163	2915630004145684+UAI163	2913109560 +
882221	29125	2912503	FCV1388B	G6919	2912529004145624	2912509560
882222	29124	2912405	FCV1857BFE	G6951FE	2915527004145504	2912409560
882223	29088	2908872	FCV1279B+FAI151	G6812+FAI151	2908826004145684+UAI151	2908809560
882224	29142	2914270	FCV1389 +	G6891 +	2914230004045724 +	2914209569 +
882225	29090	2909071	FCV1047B	G6644	2909028004145724	2909005392
882226	29131	2913171	FCV1404BFE	G6921FE	2915630004145684	2913109560
882227	29159	2915901 +	FCV1964 +	G6977 +		2915905390 +

TRW	JURATEK	ETF	TRUSTING	EFI	LUMAG
GDB5067	JCP988+JCK509	12-5278	601.0	EDB1314	291080090110
GDB5067+GIC5016	JCP988+JCK509+JCW128	12-5278	+  601.0W	EDB1314+EFA018	291080090110
GDB5067+GIC5014	JCP988+JCK509+JCW131	12-5278+BZ1065W	601.0	+  EDB1314+EFA017	291080090110
GDB5067	+  JCP988+JCK509+JCW134	12-5278	+  601.0	+  EDB988	+  290590090110
GDB5072	JCP1329+JCK509	12-5284	600.0	EDB1329	290950090110
GDB5072+GIC5016	JCP1329+JCK509+JCW128	12-5284	+  600.0	+  EDB1329	+  290950090110
GDB5072	+  JCP1329+JCK509+JCW135	12-5284	+  600.0	+  EDB1329	+  290950090110
GDB5092	JCP131+JCK509	12-5315	611.0	EFC131	
GDB5091	JCP133+JCK509	12-5314	612.0	EFC133	
GDB5093	JCP132+JCK509	12-5322	668.0	EFC132	
GDB5073	JCP1277+JCK509	12-5321	599.0	EDB1277	
GDB5065	JCP760	12-5264	602.0	EDB760	290300090110
GDB5065+GIC5011	JCP760	+  12-5264	+  602.0	+  EDB760	+  290300090110
GDB5065+GIC5009	JCP760+JCW111	12-5264	+  602.0	+  EDB760	+  290300090110
GDB5065+GIC5012	JCP760+JCW135	12-5264	+  602.0	+  EDB760	+  290300090110
GDB5000+GIC5010	JCP760	+  12-5264	+  602.0	+  EDB760	+  290300090110
GDB5065+GIC5012	JCP760+JCW135	12-5264	+  602.0	+  EDB760	+  290300090110
GDB5019+GIC5011	JCP1047	+  12-5280	+  605.0	+  EDB1047	+  290900090100
GDB5019+GIC5013	JCP1047+JCW312	12-5280	+  605.0	+  EDB1047	+  290900090100
GDB5086	+  JCP1404+JCW124	12-5310	+  603.1W	EFC124	
GDB5086+GIC5020	JCP1404	+  12-5310	+  603.0W	EFC124	
GDB5085	JCP1388	12-5317	609.0	EFC121	
GDB5082	JCP109+JCK518	12-5295	619.0	EFC109	291240090100
GDB5069+GIC5027	JCP1279+JCW123+JCK508	12-5285	+  598.3W	EDB1279+EFA026	290880090200
GDB5084+GIC5019	JCP130+JCW127+JCK521	12-5313	606.1W	EFC130+EFA030	
GDB5019	JCP1047	12-5280	605.0	EDB1047	290900090100
GDB5086	JCP1404	12-5310	603.0W	EFC124	
GDB5095	JCP1389+JCW126+JCK510	12-5318	+ 	EFC 113	+ 

<b>Valeo</b>	<b>WVA</b>	<b>TEXTAR</b>	<b>FERODO</b>	<b>ABEX</b>	<b>BERAL</b>	<b>JURID</b>
882228	29159	2915901	FCV1964	G6977		2915905390
882229	29088	2908807 + 	FCV4283 + 	G6974 + 		2908809560 + 
882230	29088	2908807	FCV4283	G6974		2908809560
882231	29011	2901105 + 98022400 (L300)	FCV773 + 	G6502 + 	2901125004034754 + 	2901104240
882232	29011	2901105	FCV773	G6502	2901125004034754	2901104240 (wear sensor included)
882233	29122	2912204+98025000 (L475)	FCV1126 + 	G6727 + 	2912222004017214 + 	2937409560 + 
882234	29122	2912204+98022300 (L495)	FCV1126 + 	G6727 + 	2912222004017214 + 	2937409560 + 
882235	29122	2912204	FCV1126	G6727	2912222004017214	2937409560
882236	29067	2906705+98028400 (L150)	FCV733 + 	G6487 + 	2906722004034754 + 	2906703342
882237	29011	2901105 + 98022400 (L300)	FCV773 + 	G6502 + 	2901125004034754 + 	2901104240
882238	29088	2908807+98024400)				2914405390 + 
882239	29835	2983506 + 98022000	FVR1522 + 	G6895 + 	2983521704040274 + 	2983505440
882240	29835	2983506	FVR1522	G6895	2983521704040274	
882241	29065	2906504 + 98022300	FVR1522 + 	G6492 + 		
882242	29065	2906504	FVR1522	G6492		
882243	29173	2917301+98028200	FCV1856B + 		2920329004145724 + 	2917309560 + 
882244	29173	2917301	FCV1856B		2920329004145724	2917309560
882245	29174	2917401+98028200	FCV1989BFE + 	G6961FE + 	2921829004145724 + 	2917409560 + 
882246	29174	2917401	FCV1989BFE	G6961FE	2921829004145724	2917409560
882247	29177	2917701+98028200	FCV4170B + 	G6964 + 	2917729004145724 + 	2917709560 + 
882248	29177	2917701	FCV4170B	G6964	2917729004145724	2917709560
882249	29181	2918101	FCV1815BFE	G6944FE	2920730004145814	
882250	29162	2916201	FCV1828	G6935		2916205390
882251	29143	2914302	FCV1367B	G6887	2914330004145504	
882254	29067	2906705	FCV733	G6487	2906722004034754	
882255	29067	2906705 + 	FCV733 + 	G6487 + 	2906722004034754 + 	
882257	29039	2903902 + 	FCV70 + 	G6398 + 	2903922004034224 + 	
882258	29067	2906705	FCV733	G6487 + 	2906722004034754 + 	2906703342
882259	29181	2918101 + 	FCV1815BFE + 	G6944FE + 	2920730004145814 + 	

TRW	JURATEK	ETF	TRUSTING	EFI	LUMAG
GDB5083	JCP1279+JCW120	12-5318		EFC 113	
GDB5069	+ JCP1279+JCW120+JCK508	598.0	+ 277.0	EDB 1279+EFA023	290880090200
GDB5069	JCP1279+JCW120	598		EDB 1279	290880090200
GDB5024+GIC5007				EDB773+EFA008	290110090110
GDB5024				EDB773	290110090110
GDB5068+GIC5017		12-5272	+ 277.0	EDB1126+EFA019	
GDB5068+GIC5017		12-5272	+ 277.0	EDB1126+EFA019	
GDB5068		12-5272	277.0	EDB1126	
GDB5058+GIC5002			278.0	+ EDB733+EFA234	
GDB5024+GIC5007				EDB773+EFA008	290110090110
GDB5069+GIC5018		12-5285	+ 598.0	+ EDB 1279+EFA023	290880090200
GDB5050+GIC5004				EDB501+EFA007	298350090210
GDB5050				EDB501	298350090210
GDB5004+GIC5004				EDB501+EFA007	290650090210
GDB5004				EDB501	290650090210
GDB5102+senor					
GDB5102					
GDB5096	+ 825.0		+ 825.0		
GDB5096			825.0		
GDB5098	+ 278.0				
GDB5098					
GDB5100					
GDB5094					
GDB5090			610.0		
GDB5058			278.0		
GDB5058	+ 278.0		278.0	+ 278.0	
GDB5058	+ 290390090210				+ 290390090210
GDB5058+GIC5002			278.0	EDB733	
GDB5100	+ 278.0				

<p>Every effort has been made to ensure that the information contained in this catalogue is correct at the time of printing, but no warranty or representation is given or made as to the accuracy of such information and Valeo Service UK Ltd does not accept any liability whatsoever for any inaccuracies.</p> <p>Valeo Service UK Ltd reserves the right to alter specifications and/or the final construction of products without notice.</p> <p>Product references referred to in this catalogue may not be available in all countries.</p>	<p>All orders for products are only accepted subject to the terms and conditions of Valeo Service UK Ltd. Photographs and drawings are not binding on Valeo Service UK Ltd. The copyright in this publication belongs to Valeo Service UK Ltd exclusively. No part of this publication may be reproduced by any means without the prior authorisation of Valeo Service UK Ltd.</p>
<p>L'affectation et la préconisation des produits figurant dans nos catalogues prennent en compte l'état du parc automobile au jour de leur parution.</p> <p>La responsabilité de Valeo Service ne saurait être engagée en cas de modification, substitution ou suppression des affectations ou préconisations qui pourraient intervenir notamment à l'initiative des constructeurs de véhicules.</p> <p>Les caractéristiques techniques de nos produits sont susceptibles d'évoluer à tout moment pour tenir compte des améliorations techniques et technologiques.</p>	<p>Certaines références peuvent ne pas être disponibles dans tous les pays.</p> <p>Les commandes sont régies par les conditions générales de vente de Valeo Service.</p> <p>Photos et dessins non contractuels. La reproduction de tout ou partie de cette publication est interdite sans l'autorisation expresse et écrite de Valeo Service.</p>
<p>La aplicación de los productos sobre vehículos y las especificaciones de los productos que figuran en nuestros catálogos se refieren a la situación del parque de automóviles en la fecha de puesta en circulación de los productos.</p> <p>Valeo Service España SA no asume ninguna responsabilidad en caso de modificación, sustitución o supresión de dichas aplicaciones y/o especificaciones que pudieran producirse por iniciativa de los fabricantes de automóviles.</p> <p>Las características técnicas de nuestros productos son susceptibles de evolucionar en cualquier momento para incorporar las mejoras técnicas y tecnológicas que se desarrollen.</p>	<p>Las referencias de productos mencionadas en este catalogo puede que no estén disponibles en todos los países.</p> <p>Los pedidos se regiran por las condiciones generales de venta de Valeo Service España SA.</p> <p>Las fotografías y dibujos que aparecen en nuestros catálogos son meramente indicativas, por lo que no siempre coinciden exactamente con la apariencia externa de nuestros productos. Se prohíbe la reproducción de todo o parte de esta publicación sin la autorización expresa y escrita de Valeo Service España SA.</p>
<p>As prescrições e recomendações relativas ao uso ou utilidade dos produtos constantes de nossos catálogos levam em consideração o estado do parque automotivo à época do lançamento desses produtos.</p> <p>A Valeo Sistemas Automotivos Ltda (Valeo Cibié Service) não será responsável por quaisquer modificações, substituições ou supressões incidentes sobre as prescrições e recomendações relativas ao uso ou utilidade de nossos produtos, que sejam decorrentes de ações dos construtores de veículos.</p> <p>As características técnicas de nossos produtos são suscetíveis de alteração a qualquer momento para que sejam incorporadas melhorias técnicas e/ou tecnológicas.</p>	<p>Certas referências podem não estar disponíveis em todos os países.</p> <p>Os pedidos feitos pelos clientes são regidos pelas condições gerais de venda da Valeo Sistemas Automotivos Ltda (Valeo Cibié Service).</p> <p>Fotos e desenhos não contratuais. A reprodução de todo ou de parte desta publicação é proibida sem a autorização expressa e por escrito da Valeo Sistemas Automotivos Ltda (Valeo Cibié Service).</p>
<p>Le applicazioni e le specifiche dei prodotti che figurano nei nostri cataloghi si riferiscono alla situazione del parco circolante al momento della pubblicazione.</p> <p>Valeo Service Italia S.p.A. declina qualsiasi responsabilità in caso di modifica, sostituzione o soppressione di applicazioni o specifiche eventualmente apportate, senza preavviso, da parte dei Costruttori.</p> <p>Le caratteristiche tecniche dei nostri prodotti sono suscettibili di modifiche in qualsiasi momento, per apportare migliorie tecniche e tecnologiche.</p>	<p>Alcuni riferimenti presenti in questo catalogo non sono disponibili in tutti i paesi.</p> <p>Gli ordini sono regolamentati dalle condizioni generali di vendita di Valeo Service Italia S.p.A.</p> <p>Le Foto ed i disegni che appaiono nel catalogo sono puramente indicativi. E' vietata la riproduzione della totalità o di una parte della presente pubblicazione senza un'esplicita autorizzazione scritta da parte di Valeo Service Italia S.p.A.</p>
<p>De ter zake van de producten in onze catalogi aangegeven bestemmingen en gedane aanbevelingen zijn gebaseerd op het wagenpark ten tijde van publicatie.</p> <p>Valeo Service Benelux B.V. sluit elke aansprakelijkheid uit met betrekking tot wijziging, vervanging of annulering van de bestemmingen of aanbevelingen, die met name op initiatief van de autofabrikanten kunnen worden doorgevoerd.</p> <p>De technische eigenschappen van onze producten kunnen te allen tijde evolueren teneinde rekening te houden met technische en technologische verbeteringen.</p>	<p>Bepaalde artikelen kunnen in bepaalde landen niet beschikbaar zijn.</p> <p>Orders zijn onderworpen aan de algemene verkoopvoorwaarden van Valeo Service Benelux B.V.</p> <p>Foto's en tekeningen zijn niet bindend.</p> <p>De gehele of gedeeltelijke verveelvoudiging van deze uitgave zonder uitdrukkelijke voorafgaande schriftelijke toestemming van Valeo Service Benelux B.V. is verboden.</p>
<p>Die Verwendungsempfehlungen zu den in diesem Katalog aufgeführten Produkten beziehen sich auf den zum Zeitpunkt des Erscheinens dieses Katalogs existierenden Fahrzeugbestand.</p> <p>Valeo Service Deutschland GmbH übernimmt keine Haftung für Änderungen, Ersetzungen oder Streichungen der Fahrzeuganwendung oder -Empfehlungen, die besonders auf Initiative der Fahrzeughersteller auftreten können.</p> <p>Die technischen Eigenschaften unserer Produkte unterliegen ständiger Entwicklung, um technischen und technologischen Verbesserungen Rechnung zu tragen.</p>	<p>Die Fotos oder Zeichnungen in diesem Katalog dienen ausschließlich der Veranschaulichung unserer Produkte. Rechtliche Ansprüche können daraus nicht abgeleitet werden.</p> <p>Einige Produktreferenzen sind nicht in allen Ländern verfügbar.</p> <p>Lieferungen unterliegen den Allgemeinen Verkaufsbedingungen von Valeo Service Deutschland GmbH.</p> <p>Die Vervielfältigung dieses Katalogs oder Teilen davon ohne die schriftliche Erlaubnis von Valeo Service Deutschland GmbH ist nicht zulässig.</p>
<p>Przeznaczenie i zalecenia dotyczące produktów figurujących w naszych katalogach biorą pod uwagę stan parku samochodowego w dniu ich wprowadzenia na rynek.</p> <p>Spółka «Valeo Service Eastern Europe Sp.oz.o.» nie może być ponosić odpowiedzialności w przypadku zmiany, zastąpienia lub usunięcia wskazań dotyczących przeznaczenia i zaleceń, które mogą wystąpić z inicjatywy producentów samochodów.</p> <p>Dane techniczne naszych produktów mogą być w każdej chwili zmienione w celu uwzględnienia</p>	<p>ulepszeń technicznych i technologicznych.</p> <p>Niektóre modele mogą być niedostępne w niektórych krajach.</p> <p>Zamówienia podlegają ogólnym warunkom umów «Valeo Service Eastern Europe Sp.oz.o.».</p> <p>Wykorzystywanie w całości lub w części zdjęć i rysunków zamieszczonych w naszych katalogach wymaga pisemnej zgody «Valeo Service Eastern Europe Sp.oz.o.».</p>
<p>Učinili jsme všechny kroky nezbytné k tomu, aby informace v tomto dokumentu byly přesné ke dni jeho tisku. Valeo Service Export nezodpovídá za případné neúplné či chybné informace zde uvedené.</p> <p>Valeo Service Export si vyhrazuje právo úprav specifikace a/nebo konečné formy výrobku bez předchozího upozornění.</p>	<p>Katalogová čísla obsažená v tomto katalogu nemusi být dostupná k prodeji na všech trzích. Konečné objednávky výrobků se řídí obchodními podmínkami Valeo Service Export.</p> <p>Fotografie a technické nákresy nezávisí na Valeo Service Export. Copyright je exkluzivní Valeo Service Export. Žádná část tohoto katalogu nesmí být kopírována bez autorizace Valeo Service Export.</p>
<p>A VALEO teljes tudásával arra törekszik, hogy a katalógusban szereplő adatok műszaki tartalma teljesen korrekt legyen, ezért a VALEO SERVICE EXPORT nem vállal garanciát azok helyességéért, pontatlanságáért és nem terheli felelősség az esetleges hibákból eredő károkat.</p> <p>A VALEO SERVICE EXPORT fenntartja a jogot a termékváltoztatásokra mellékelt termékinformáció nélkül.</p> <p>A katalógusban szereplő cikkszámok között előfordulhatnak olyanok is, melyek nem minden országban kerülnek forgalomba.</p>	<p>Minden termék rendelés a VALEO SERVICE EXPORT szerződéses kondíciói alapján érvényes.</p> <p>A katalógusban szereplő fényképek és rajzok nem a VALEO SERVICE EXPORT készítményei. A szerzői jogok a VALEO SERVICE EXPORT kizárólagos tulajdonát képezik.</p> <p>A kiadvány részét nem képező reprodukciókhoz nem szükséges a VALEO SERVICE EXPORT engedélye.</p>
<p>Назначение и рекомендации по эксплуатации продукции, содержащиеся в наших каталогах, указываются с учетом состояния автомобильного парка на день ее появления.</p> <p>Компания «Valeo Service Eastern Europe Sp.oz.o.» не несет ответственности в случае внесения изменений в рекомендации по эксплуатации продукции или их устранения, произошедших, в частности, по инициативе производителей автомобилей.</p> <p>Технические характеристики нашей продукции могут претерпевать изменения в любой момент, с учетом усовершенствования технических и технологических процессов.</p>	<p>Некоторые виды продукции могут не иметься в наличии в отдельных странах.</p> <p>Заказы осуществляются согласно общим правилам торговли, применяемым в компании «Valeo Service Eastern Europe Sp.oz.o.».</p> <p>Фотографии и изображения продукции могут не в полной мере соответствовать оригиналам. Воспроизведение всей или части настоящей публикации запрещено без специального письменного согласия компании «Valeo Service Eastern Europe Sp.oz.o.».</p>
<p>Kataloglarımızda yer alan ürünlerin kullanım ve tanımları, otomobil parkının yaygın tarihindeki durumuna göredir.</p> <p>Valeo Otomotiv Dağıtım AS, özellikle araç, üreticilerinin inisiyatifli sonucunu yapılan değişiklikler, ikame veya kaldırılmalarıdan sorumlu tutulamaz.</p> <p>Ürünlerimiz teknik özellikleri, teknik ve teknolojik gelişmelere paralel olarak geliştirilebilir.</p>	<p>Bazı referanslar bazı ülkelerde bulunmayabilir.</p> <p>Siparişler, Valeo Otomotiv Dağıtım AS'un genel satış koşullarına uygun olarak ödenir.</p> <p>Fotoğraf ve resimler akdi değildir. İşbu yayının Valeo Otomotiv Dağıtım AS'un önceden verilmiş yazılı izni olmaksızın kısmen veya tamamen çoğaltılması yasaktır.</p>
<p>O katalógos éχει συσταθεί λαμβάνοντας υπόψη τη σύσταση του στολου αυτοκινητών την ημέρα, της κυκλοφορίας του.</p> <p>Η Valeo δε φέρει ευθύνη σε περίπτωση τροποποίησης, αλλαγής ή αντικατάστασης κάποιου αντ/κου που περιέχεται στο κατάλογο, εξαιτίας πρωτοβουλίας του κατασκευαστή του οχήματος.</p> <p>Τα τεχνικά χαρακτηριστικά των προϊόντων ενδέχεται να διαφοροποιηθούν ανά πάσα στιγμή λόγω τεχνολογικών εξελίξεων.</p> <p>Μερικοί κωδικοί αντ/κων μπορεί να μην είναι διαθέσιμοι σε κάποιες χώρες.</p>	<p>Οι παραγγελίες υπεκκείνται στους γενικούς όρους πωλήσεων της Valeo.</p> <p>Οι φωτογραφίες και τα σχέδια δεν είναι δεσμευτικά. Η αναπαραγωγή ολοκληρωτή ή τμήματος αυτού του καταλόγου απαγορεύεται να γίνει χωρίς τη ρητή και γραπτή άδεια της Valeo Service.</p>

## EUROPE

### FRANCE

#### VALEO SERVICE FRANCE

70, RUE PLEYEL  
93285 SAINT-DENIS CEDEX - FRANCE  
TEL. : (+33) 1 49 45 32 32  
FAX : (+33) 1 49 45 37 36  
S.A.S. au capital de 12 900 000 €  
RCS Bobigny B 306 486 408

### SPAIN, PORTUGAL

#### VALEO SERVICE ESPAÑA, S.A.

CALLE RIO ALMANZORA, Nº5  
AREA EMPRESARIAL ANDALUCIA C.L.A.  
28906 GETAFE (MADRID) - ESPAÑA  
TEL. : (+34) 91 495 85 00  
FAX : (+34) 91 495 86 99  
TEL. ATENCIÓN TÉCNICA :  
902 011 799  
TEL. ATENCIÓN AL CLIENTE :  
900 122 657  
Valeo Service España Sociedad Anónima  
inscrita en el Registro Mercantil de Madrid,  
Tomo 972 - Libro 941 de la sección 8ª,  
Folio 25 - Hoja 65435 - Inscripción 1ª NIF. A28772978

### ITALY

#### VALEO SERVICE ITALIA SPA

VIA ASTI 89  
10026 SANTENA (TO) - ITALIA  
TEL. : (+39) 011 94 95 1  
FAX : (+39) 011 94 95 280  
TEL. LINEA TECNICA : 800 805 046  
N. iscrizione al Tribunale di Torino 2009/88 reg. soc.  
C.C.I.A.A. 715107 - Capitale sociale € 2.600.000

### UNITED KINGDOM

#### VALEO SERVICE UK LTD

HEMING ROAD - WASHFORD  
REDDITCH - WORCS B98 0DZ - ENGLAND  
TEL. : (+44) 1527 838 300  
FAX : (+44) 1527 523 732  
Registration Number : 956685

### GERMANY

#### VALEO SERVICE DEUTSCHLAND GMBH

BRANDENBURGER STRASSE 46  
40880 RATINGEN - DEUTSCHLAND  
TEL. : (+49) 21 02 865 0  
FAX : (+49) 21 02 865 142  
Handelsregister Ratingen - HRB 3340

### BENELUX

#### VALEO SERVICE BENELUX B.V.

HEIBLOEMWEG 1  
5704 BS HELMOND - THE NETHERLANDS  
TEL. BELGIUM (NL) : (+32) 2 366 99 17  
TEL. BELGIUM (FR) : (+32) 2 355 14 46  
TEL. NETHERLANDS : (+31) 492 580 894  
FAX BELGIUM : (+32) 2 366 04 47  
FAX NETHERLANDS : (+31) 492 580 828  
K.v.K. Eindhoven 33113859

## POLAND, LITHUANIA, LATVIA, ESTONIA, MOLDAVIA, BELARUS, UKRAINE

#### VALEO SERVICE EASTERN EUROPE SP. ZO.O.

UL. WOŁOSKA 9A  
02-583 WARSZAWA - POLSKA  
TEL. : (+48) 22 543 43 00  
FAX : (+48) 22 543 43 05

### RUSSIA

#### VALEO SERVICE CO LTD

RUSSIA, 105055, MOSCOW  
RADIO STR, 24 - BUILD.2  
TEL. : (+7) 495 981-06-96  
FAX : (+7) 495 787-59-92

## SWITZERLAND, AUSTRIA, SWEDEN, FINLAND, NORWAY, DENMARK, ICELAND, GREECE, EASTERN EUROPE

#### VALEO SERVICE EXPORT

70, RUE PLEYEL  
93285 SAINT-DENIS CEDEX - FRANCE  
TEL. : (+33) 01 49 45 32 32  
FAX : (+33) 01 49 45 36 59

#### LIAISON OFFICE IN AUSTRIA

MÜHLGASSE 7  
2380 PERCHTOLDSBORF - AUSTRIA  
TEL. : (+43) 1 480 42 46  
FAX. : (+43) 1 480 42 34

#### LIAISON OFFICE IN CZECH REPUBLIC

DEDINSKA 29  
16101 PRAGUE 6 - CZECH REPUBLIC  
TEL. : (+420) 220 102 277  
FAX. : (+420) 220 102 278

#### LIAISON OFFICE IN HUNGARY

ROZSAKVARC UTCA 33  
1188 BUDAPEST- HUNGARY  
TEL. : (+36) 30 50 51 888

#### LIAISON OFFICE IN ROMANIA

STR.CA ROSETTI NR.17  
SECTOR 2  
02001 BUCURESTI - ROMANIA  
TEL. : (+40) 215 27 03 80

#### LIAISON OFFICE IN SERBIA

BULEVAR ARSENIJA CARNOJEVICA 99, LOKAL 4  
11070 BELGRADE - SERBIA  
TEL/FAX. : +381 (0)11 260 7754

#### LIAISON OFFICE IN GREECE

18, KALAMAKIOU AVENUE  
174 55 ALIMOS - GREECE  
TEL. : (+30) 210 45 27 447  
FAX. : (+30) 210 45 27 449

## SOUTH AMERICA

### LATIN AMERICA (except Mexico)

#### VALEO CIBIE SERVICE LTDA

RUA SADAE TAKAGI, 2000  
BAIRRO COOPERATIVA  
09852-070 - SÃO BERNARDO DO CAMPO  
SÃO PAULO - BRASIL  
TEL. : (+55) 11 43 93 33 54  
FAX : (+55) 11 43 93 33 55  
C.N.P.J. : 57.010.662/0008-36  
Inscrição Estadual : 635.331.124.114

### MEXICO

#### LIAISON OFFICE IN MEXICO

MONTECITO 38, PISO 14 OFICINA 38.  
TORRE WORLD TRADE CENTER  
COLONIA NÁPOLES | 03810| MÉXICO, D.F.  
TEL. : +52 (55) 90001588

## ASIA, MIDDLE EAST, AUSTRALIA, NEW-ZEALAND

#### VALEO SERVICE EXPORT

70, RUE PLEYEL  
93285 SAINT-DENIS CEDEX - FRANCE  
TEL. : (+33) 01 49 45 32 32  
FAX : (+33) 01 49 45 36 59

### CHINA

#### VALEO AUTO PART TRADING (SHANGHAI) CO., LTD

7 FLOOR, INNOV TOWER, 1801 HONG MEI ROAD,  
CAOHEJING HI-TECH PARK, XUHUI  
DISTRICT, SHANGHAI 200233, CHINA  
TEL. : (+86) 21 5171 3576  
MP : (+86) 139 1750 0406

### TURKEY, IRAN, IRAQ, SYRIA, LEBANON, JORDAN, SAUDI ARABIA, UNITED ARABE EMIRATES, KUWAIT, BAHRAIN, QATAR, OMAN, YEMEN, EGYPT

#### VALEO OTOMOTIV DAĞITIM A.Ş.

AYDINEVLER SANAYI CADDESİ  
CENTRUM IS MERKEZİ N°3  
KAT: 3, DAIRE N°302-303 KÜÇÜKYALI - MALTEPE  
34854 ISTANBUL - TURKEY  
TEL. : (+90) 216 518 75 75  
FAX : (+90) 216 519 93 14

## AFRICA, DOM-TOM

#### VALEO SERVICE EXPORT

70, RUE PLEYEL  
93285 SAINT-DENIS CEDEX - FRANCE  
TEL. : (+33) 01 49 45 32 32  
FAX : (+33) 01 49 45 36 59  
S.A.S. au capital de 12 900 000 €  
RCS Bobigny B 306 486 408

#### LIAISON OFFICE IN TUNISIA

CENTRE D'AFFAIRES REGUS  
IMMEUBLE CARTHAGE  
RUE DU LAC DE CONSTANCE  
1053 TUNIS - TUNISIA  
TEL. : (216) 71 965 002  
FAX : (216) 71 965 137  
MOB: (216) 98 34 91 38



# Truck by Valeo

## Your solution provider

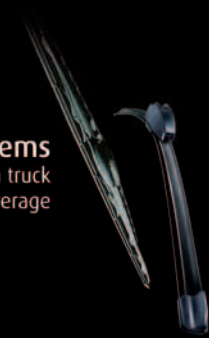

**Wiping systems**  
99% European truck park coverage

**Tank caps collection**  
A full range for fuel and AdBlue® tanks



**Braking systems**  
Only one supplier for a full braking offer



**Alternators & Starters**  
The OE quality for the Aftermarket



**Clutches**  
One truck out of two in Europe are fitted with a Valeo clutch



**Lighting systems**  
OE lighting for your trucks & buses



**Air Quality products**  
for professional drivers



**Climate Control**  
Most popular Trucks covered by Valeo O.E. offer!



**Engine cooling**  
Irreproachable quality products



valeo added 

Automotive technology, naturally

